

ONKYO®

Compact Disc Player

DX-7555

Instruction Manual

Thank you for purchasing an Onkyo Compact Disc Player. Please read this manual thoroughly before making connections and plugging in the unit. Following the instructions in this manual will enable you to obtain optimum performance and listening enjoyment from your new Compact Disc Player. Please retain this manual for future reference.

Contents

Introduction 2

Connections 10

Operation 12

Others 23

WARNING:

TO REDUCE THE RISK OF FIRE OR ELECTRIC SHOCK, DO NOT EXPOSE THIS APPARATUS TO RAIN OR MOISTURE.

CAUTION:

TO REDUCE THE RISK OF ELECTRIC SHOCK, DO NOT REMOVE COVER (OR BACK). NO USER-SERVICEABLE PARTS INSIDE. REFER SERVICING TO QUALIFIED SERVICE PERSONNEL.



WARNING
RISK OF ELECTRIC SHOCK
DO NOT OPEN

AVIS
RISQUE DE CHOC ELECTRIQUE
NE PAS OUVRIR



The lightning flash with arrowhead symbol, within an equilateral triangle, is intended to alert the user to the presence of uninsulated “dangerous voltage” within the product’s enclosure that may be of sufficient magnitude to constitute a risk of electric shock to persons.



The exclamation point within an equilateral triangle is intended to alert the user to the presence of important operating and maintenance (servicing) instructions in the literature accompanying the appliance.

Important Safety Instructions

1. Read these instructions.
2. Keep these instructions.
3. Heed all warnings.
4. Follow all instructions.
5. Do not use this apparatus near water.
6. Clean only with dry cloth.
7. Do not block any ventilation openings. Install in accordance with the manufacturer’s instructions.
8. Do not install near any heat sources such as radiators, heat registers, stoves, or other apparatus (including amplifiers) that produce heat.
9. Do not defeat the safety purpose of the polarized or grounding-type plug. A polarized plug has two blades with one wider than the other. A grounding type plug has two blades and a third grounding prong. The wide blade or the third prong are provided for your safety. If the provided plug does not fit into your outlet, consult an electrician for replacement of the obsolete outlet.
10. Protect the power cord from being walked on or pinched particularly at plugs, convenience receptacles, and the point where they exit from the apparatus.
11. Only use attachments/accessories specified by the manufacturer.
12. Use only with the cart, stand, tripod, bracket, or table specified by the manufacturer, or sold with the apparatus. When a cart is used, use caution when moving the cart/apparatus combination to avoid injury from tip-over.

PORTABLE CART WARNING
S3125A
13. Unplug this apparatus during lightning storms or when unused for long periods of time.
14. Refer all servicing to qualified service personnel. Servicing is required when the apparatus has been damaged in any way, such as power-supply cord or plug is damaged, liquid has been spilled or objects have fallen into the apparatus, the apparatus has been exposed to rain or moisture, does not operate normally, or has been dropped.
15. Damage Requiring Service
Unplug the apparatus from the wall outlet and refer servicing to qualified service personnel under the following conditions:
 - A. When the power-supply cord or plug is damaged,
 - B. If liquid has been spilled, or objects have fallen into the apparatus,
 - C. If the apparatus has been exposed to rain or water,
 - D. If the apparatus does not operate normally by following the operating instructions. Adjust only those controls that are covered by the operating instructions as an improper adjustment of other controls may result in damage and will often require extensive work by a qualified technician to restore the apparatus to its normal operation,
 - E. If the apparatus has been dropped or damaged in any way, and
 - F. When the apparatus exhibits a distinct change in performance this indicates a need for service.
16. Object and Liquid Entry
Never push objects of any kind into the apparatus through openings as they may touch dangerous voltage points or short-out parts that could result in a fire or electric shock.
The apparatus shall not be exposed to dripping or splashing and no objects filled with liquids, such as vases shall be placed on the apparatus.
Don’t put candles or other burning objects on top of this unit.
17. Batteries
Always consider the environmental issues and follow local regulations when disposing of batteries.
18. If you install the apparatus in a built-in installation, such as a bookcase or rack, ensure that there is adequate ventilation.
Leave 20 cm (8") of free space at the top and sides and 10 cm (4") at the rear. The rear edge of the shelf or board above the apparatus shall be set 10 cm (4") away from the rear panel or wall, creating a flue-like gap for warm air to escape.

Precautions

1. **Recording Copyright**—Unless it's for personal use only, recording copyrighted material is illegal without the permission of the copyright holder.
2. **AC Fuse**—The AC fuse inside the unit is not user-serviceable. If you cannot turn on the unit, contact your Onkyo dealer.
3. **Care**—Occasionally you should dust the unit all over with a soft cloth. For stubborn stains, use a soft cloth dampened with a weak solution of mild detergent and water. Dry the unit immediately afterwards with a clean cloth. Don't use abrasive cloths, thinners, alcohol, or other chemical solvents, because they may damage the finish or remove the panel lettering.

4. Power WARNING

BEFORE PLUGGING IN THE UNIT FOR THE FIRST TIME, READ THE FOLLOWING SECTION CAREFULLY.

AC outlet voltages vary from country to country. Make sure that the voltage in your area meets the voltage requirements printed on the unit's rear panel (e.g., AC 230 V, 50 Hz or AC 120 V, 60 Hz).

The unit is not fully powered off, while the STANDBY indicator stays lit up. If you do not intend to use the unit for an extended period, remove the power cord from the AC outlet.

5. **Never Touch this Unit with Wet Hands**—Never handle this unit or its power cord while your hands are wet or damp. If water or any other liquid gets inside this unit, have it checked by your Onkyo dealer.
6. **Handling Notes**
 - If you need to transport this unit, use the original packaging to pack it how it was when you originally bought it.
 - Do not leave rubber or plastic items on this unit for a long time, because they may leave marks on the case.
 - This unit's top and rear panels may get warm after prolonged use. This is normal.
 - If you do not use this unit for a long time, it may not work properly the next time you turn it on, so be sure to use it occasionally.
 - When you've finished using this unit, remove all discs and turn off the power.

7. Installing this Unit

- Install this unit in a well-ventilated location.
- Ensure that there's adequate ventilation all around this unit, especially if it's installed in an audio rack. If the ventilation is inadequate, the unit may overheat, leading to malfunction.
- Do not expose this unit to direct sunlight or heat sources, because its internal temperature may rise, shortening the life of the optical pickup.

- Avoid damp and dusty places, and places subject to vibrations from loudspeakers. Never put the unit on top of, or directly above a loudspeaker.
 - Install this unit horizontally. Never use it on its side or on a sloping surface, because it may cause a malfunction.
 - If you install this unit near a TV, radio, or VCR, the picture and sound quality may be affected. If this occurs, move this unit away from the TV, radio, or VCR.
8. **To Obtain a Clear Picture**—This unit is a high-tech, precision device. If the lens on the optical pickup, or the disc drive mechanism becomes dirty or worn, the picture quality may be affected. To maintain the best picture quality, we recommend regular inspection and maintenance (cleaning or worn part replacement) every 1,000 hours of use depending on the operating environment. Contact your Onkyo dealer for details.

9. Moisture Condensation

Moisture condensation may damage this unit.

Read the following carefully:

Moisture may condense on the lens of the optical pickup, one of the most important parts inside this unit.

- Moisture condensation can occur in the following situations:
 - The unit is moved from a cold place to a warm place.
 - A heater is turned on, or cold air from an air conditioner is hitting the unit.
 - In the summer, when this unit is moved from an air conditioned room to a hot and humid place.
 - The unit is used in a humid place.
- Do not use this unit when there's the possibility of moisture condensation occurring. Doing so may damage your discs and certain parts inside this unit.

If condensation does occur, remove all discs and leave this unit turned on for two to three hours. By this time, the unit will have warmed up and any condensation will have evaporated.

For European Models

Declaration of Conformity

We, ONKYO EUROPE
ELECTRONICS GmbH
LIEGNITZERSTRASSE 6,
82194 GROEBENZELL,
GERMANY



declare in own responsibility, that the ONKYO product described in this instruction manual is in compliance with the corresponding technical standards such as EN60065, EN55013, EN55020 and EN61000-3-2, -3-3.

GROEBENZELL, GERMANY

K. MIYAGI

ONKYO EUROPE ELECTRONICS GmbH

For British models

Replacement and mounting of an AC plug on the power supply cord of this unit should be performed only by qualified service personnel.

IMPORTANT

The wires in the mains lead are coloured in accordance with the following code:

Blue: Neutral
Brown: Live

As the colours of the wires in the mains lead of this apparatus may not correspond with the coloured markings identifying the terminals in your plug, proceed as follows:

The wire which is coloured blue must be connected to the terminal which is marked with the letter N or coloured black.

The wire which is coloured brown must be connected to the terminal which is marked with the letter L or coloured red.

IMPORTANT

The plug is fitted with an appropriate fuse. If the fuse needs to be replaced, the replacement fuse must be approved by ASTA or BSI to BS1362 and have the same ampere rating as that indicated on the plug. Check for the ASTA mark or the BSI mark on the body of the fuse.

If the power cord's plug is not suitable for your socket outlets, cut it off and fit a suitable plug. Fit a suitable fuse in the plug.

This unit contains a semiconductor laser system and is classified as a "CLASS 1 LASER PRODUCT". So, to use this model properly, read this Instruction Manual carefully. In case of any trouble, please contact the store where you purchased the unit.

To prevent being exposed to the laser beam, do not try to open the enclosure.

DANGER:

VISIBLE AND/OR INVISIBLE LASER RADIATION WHEN OPEN AND INTERLOCK FAILED OR DEFEATED. DO NOT STARE INTO BEAM.

CAUTION:

THIS PRODUCT UTILIZES A LASER. USE OF CONTROLS OR ADJUSTMENTS OR PERFORMANCE OF PROCEDURES OTHER THAN THOSE SPECIFIED HEREIN MAY RESULT IN HAZARDOUS RADIATION EXPOSURE.

The label on the right is applied on the rear panel.



1. This unit is a CLASS 1 LASER PRODUCT and employs a laser inside the cabinet.
2. To prevent the laser from being exposed, do not remove the cover. Refer servicing to qualified personnel.

For U.S. models

FCC Information for User

CAUTION:

The user changes or modifications not expressly approved by the party responsible for compliance could void the user's authority to operate the equipment.

NOTE:

This equipment has been tested and found to comply with the limits for a Class B digital device, pursuant to Part 15 of the FCC Rules. These limits are designed to provide reasonable protection against harmful interference in a residential installation.

This equipment generates, uses and can radiate radio frequency energy and, if not installed and used in accordance with the instructions, may cause harmful interference to radio communications. However, there is no guarantee that interference will not occur in a particular installation. If this equipment does cause harmful interference to radio or television reception, which can be determined by turning the equipment off and on, the user is encouraged to try to correct the interference by one or more of the following measures:

- Reorient or relocate the receiving antenna.
- Increase the separation between the equipment and receiver.
- Connect the equipment into an outlet on a circuit different from that to which the receiver is connected.
- Consult the dealer or an experienced radio/TV technician for help.

For Canadian Models

NOTE: THIS CLASS B DIGITAL APPARATUS COMPLIES WITH CANADIAN ICES-003.

For models having a power cord with a polarized plug:

CAUTION: TO PREVENT ELECTRIC SHOCK, MATCH WIDE BLADE OF PLUG TO WIDE SLOT, FULLY INSERT.

Modèle pour les Canadien

REMARQUE: CET APPAREIL NUMÉRIQUE DE LA CLASSE B EST CONFORME À LA NORME NMB-003 DU CANADA.

Sur les modèles dont la fiche est polarisée:

ATTENTION: POUR ÉVITER LES CHOCS ÉLECTRIQUES, INTRODUIRE LA LAME LA PLUS LARGE DE LA FICHE DANS LA BORNE CORRESPONDANTE DE LA PRISE ET POUSSER JUSQU'AU FOND.

Features

- ❑ Plays Audio CDs, MP3 CDs, CD-R/RWs
- ❑ VLSC (Vector Linear Shaping Circuitry)
- ❑ Super Precision Clock (± 1.5 ppm)
- ❑ Massive Power Transformer
- ❑ Wolfson 192 kHz/24-Bit D/A Converter
- ❑ 2 Digital Outputs (Optical/Coaxial)
- ❑ Headphone Jack with Volume Control
- ❑ Quick Navigation for MP3 CD Playback
- ❑ 4-Mode Dimmer
- ❑ 4 Repeat Modes
- ❑ Hi-Rigidity, Anti-Resonant Chassis
- ❑ Brushed Hairline Aluminum Front Panel
- ❑ **RI** (Remote Interactive) System
Compatible
- ❑ Remote Control

Supplied Accessories

Make sure you have the following accessories:

Audio cable (1 m)

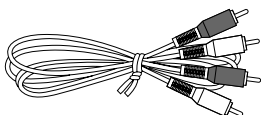

RI cable (80 cm)

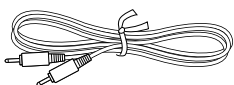

- To use **RI**, the DX-7555 must be connected with an **RI** cable and an audio cable.

Remote controller RC-625C & two batteries (AA/R6)

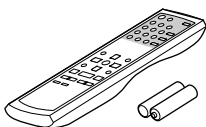

In catalogs and on packaging, the letter added to the end of the product name indicates the color of the DX-7555. Specifications and operation are the same regardless of color.

Table of Contents

Introduction

Important Safety Instructions	2
Precautions	3
Features	5
Supplied Accessories	5
Table of Contents	5
Front & Rear Panels	6
Front Panel & Display	6
Rear Panel	7
Remote Controller	8
RC-625C Remote Controller	8
Before Using the DX-7555	9
Installing the Remote Controller's Batteries	9
Using the Remote Controller	9

Connections

Connecting the DX-7555	10
Audio Connections	10
RI Connections	11

Operation

Turning On the DX-7555	12
Turning On the DX-7555	12
Playing CDs	12
Playing CDs	12
Selecting MP3 Folders & Tracks by Number	15
Displaying Information	16
Memory Playback	17
Random Playback	18
Repeat Playback	18
Various Settings	19

Others

About CDs	23
Troubleshooting	25
Specifications	27

Front & Rear Panels

The page numbers in parentheses show where you can find the main explanation for each item.

Front Panel & Display

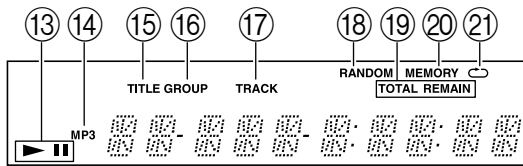
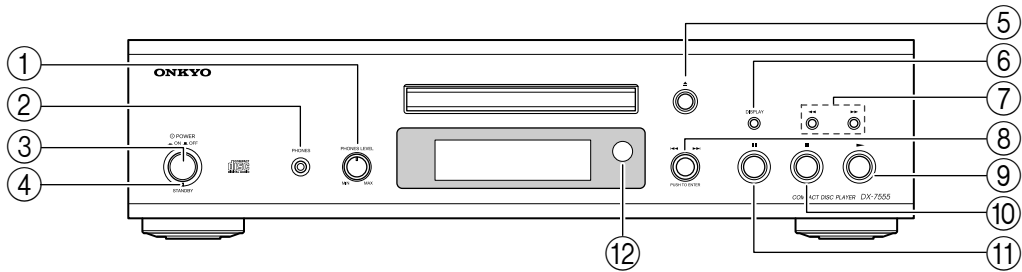

Display

- ① **PHONES LEVEL knob**
Use to control the phones level. Turn the dial clockwise to increase the phones level and counterclockwise to decrease it.
- ② **PHONES jack**
This is a standard stereo jack for connecting stereo headphones.
- ③ **POWER switch (12)**
Press to turn on/off the DX-7555.
- ④ **STANDBY indicator (12)**
Lights up when the DX-7555 is in Standby mode.
- ⑤ **Open/Close [▲] button (12)**
Press to open and close the disc tray.
- ⑥ **DISPLAY button (16)**
Press to change the displayed information.
- ⑦ **[◀/▶] buttons (13)**
Press and hold to fast reverse or fast forward during playback.
- ⑧ **[◀/▶] dial (13)**
Rotate the dial in a clockwise or counterclockwise direction to select a next or previous track. To start playback for a selected track, press the button. For MP3 disc, the dial can be used for navigation.
- ⑨ **Play [▶] button (12)**
Press to start playback.
- ⑩ **Stop [■] button (13)**
Press to stop playback.
- ⑪ **Pause [⏸] button (13)**
Press to pause playback
- ⑫ **Remote Control Sensor (9)**
- ⑬ **Play & Pause indicators**
Illuminate in play or pause mode.
- ⑭ **MP3 indicator**
Illuminates when MP3 disc is loaded.

- ⑮ **TITLE indicator**
Illuminates when the title (ID3 Tags) is displayed for MP3 file.
- ⑯ **GROUP (FOLDER) indicator**
Illuminates when the group (folder) number is displayed for the selected MP3.
- ⑰ **TRACK indicator**
Illuminates when the track number is displayed.
- ⑱ **RANDOM indicator (18)**
Illuminates during random playback.
- ⑲ **TOTAL & REMAIN indicators**
Illuminate when the remaining time is shown. (Only when audio CD is loaded; not available when MP3 disc is loaded.)
REMAIN: Displays the remaining playback time of the track.
TOTAL REMAIN: Displays the remaining playback time of the disc.
- ⑳ **MEMORY indicator (17)**
Illuminates during memory playback.
- ㉑ **Repeat indicator (18)**
Illuminates during repeat playback.

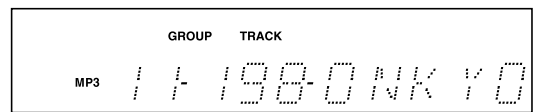

* Folders (directories) are referred to as *groups*.
Example of display for MP3 disc.

Rear Panel

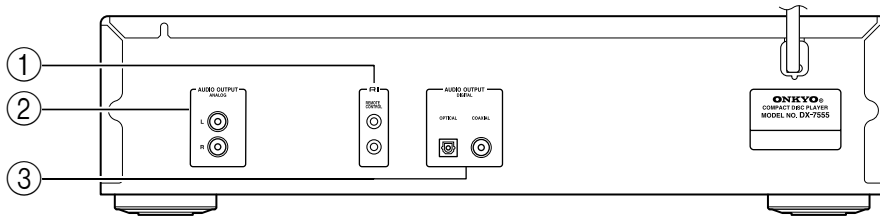

① **RI REMOTE CONTROL jacks (11)**

These two identical **RI** (Remote Interactive) jacks can be connected to the **RI** jacks on your other Onkyo components for interactive control. To use **RI**, the DX-7555 must be connected with an **RI** cable and an audio cable.

② **AUDIO OUTPUT ANALOG (10)**

This analog audio output can be connected to an amplifier's analog input by using the supplied audio cable.

③ **AUDIO OUTPUT DIGITAL OPTICAL/COAXIAL (10)**

These two digital audio outputs can be connected to a digital audio input on an amplifier or recorder.

Remote Controller

RC-625C Remote Controller

The page numbers in parentheses show where you can find the main explanation for each item.

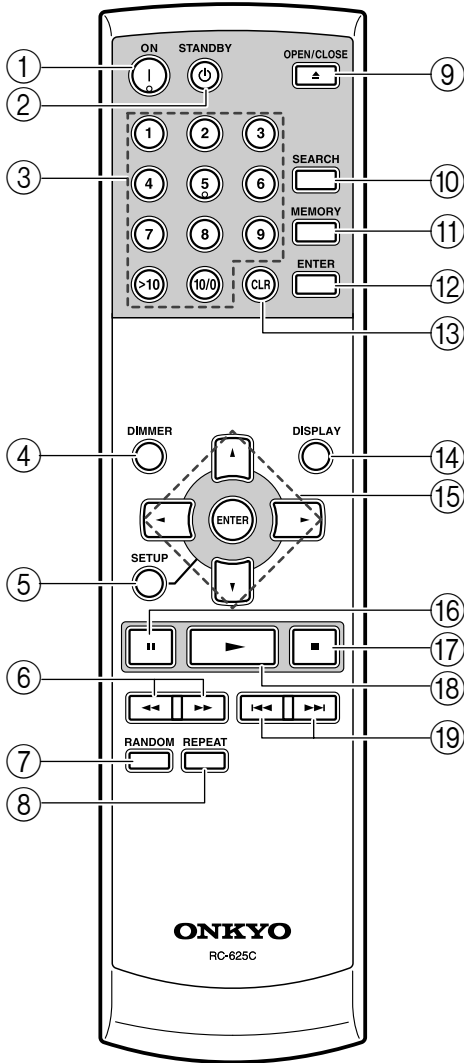

- ① **ON button (12)**
Press to turn on the DX-7555 from its standby mode.
- ② **STANDBY button (12)**
Press to put the DX-7555 on standby from its powered on status.
- ③ **Number buttons (13, 15)**
Use these buttons to enter track numbers.
- ④ **DIMMER button**
Press to adjust the display brightness. The brightness changes in this order:

□ → Normal → Dim → Dimmer → No Display*

* When the display is set to turn off (No Display), any operation will temporarily turn on the display for several seconds, then turn it off again.

- ⑤ **SETUP button (20)**
Press to display the screen for various settings.
- ⑥ **[◀/▶] buttons (13)**
Press and hold to fast reverse or fast forward during playback.
- ⑦ **RANDOM button (18)**
Press to set random playback.
- ⑧ **REPEAT button (18)**
Press to set repeat playback.
- ⑨ **OPEN/CLOSE button (12)**
Press to open and close the disc tray.
- ⑩ **SEARCH button**
Press to search and select a track number.
For MP3 disc, the button can be used to search and select a group (folder) number.
- ⑪ **MEMORY button (17)**
Press to set memory program.
- ⑫ **ENTER button**
Press to set a selected preference.
- ⑬ **CLEAR button (17)**
Press to cancel an input of data, while entering numeric values.
Press to remove the last track in the program, while registering memory.
- ⑭ **DISPLAY button (16)**
Press to change the displayed information.
- ⑮ **Arrow and ENTER buttons**
Press the Arrow buttons to configure various settings, and then press the ENTER or Arrow buttons to set them.
These buttons can be also used to select a track.
- ⑯ **Pause [||] button (13)**
Press to pause playback.
- ⑰ **Stop [■] button (13)**
Press to stop playback.
- ⑱ **Play [▶] button (12)**
Press to start playback.
- ⑲ **[◀◀/▶▶] buttons (13)**
Press to select the previous or next track.

Before Using the DX-7555

Installing the Remote Controller's Batteries

- 1 To open the battery compartment, press the small hollow and slide open the cover.

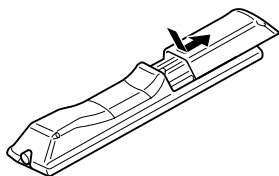

- 2 Insert the two supplied batteries (AA/R6) in accordance with the polarity diagram inside the battery compartment.

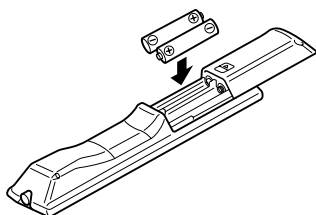

- 3 Slide the cover shut.

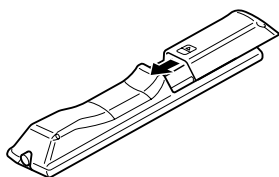

Notes:

- If the remote controller doesn't work reliably, try replacing the batteries.
- Don't mix new and old batteries or different types of batteries.
- If you intend not to use the remote controller for a long time, remove the batteries to prevent damage from leakage or corrosion.
- Flat batteries should be removed as soon as possible to prevent damage from leakage or corrosion.

Using the Remote Controller

To use the remote controller, point it at the DX-7555's remote control sensor, as shown.

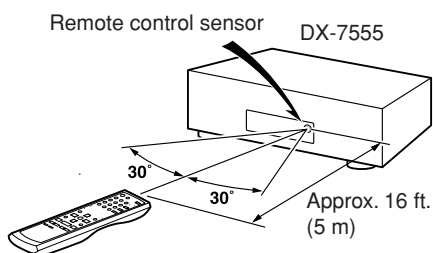

Notes:

- The remote controller may not work reliably if the DX-7555 is subjected to bright light, such as direct sunlight or inverter-type fluorescent lights. Keep this in mind when installing the DX-7555.
- If another remote controller of the same type is used in the same room, or the DX-7555 is installed close to equipment that uses infrared rays, the remote controller may not work reliably.
- Don't put anything, such as a book, on the remote controller, because the buttons may be pressed inadvertently, thereby draining the batteries.
- The remote controller may not work reliably if the DX-7555 is installed in a rack behind colored glass doors. Keep this in mind when installing the DX-7555.
- The remote controller will not work if there's an obstacle between it and the DX-7555's remote control sensor.

Connecting the DX-7555

Audio Connections

- Read the manuals supplied with your other audio equipment.
- Don't connect the power cord until you've completed all audio connections.

ANALOG AUDIO OUTPUT

If your hi-fi amp or AV receiver doesn't have a digital input, use the supplied RCA/phono audio connecting cable to connect the DX-7555's ANALOG AUDIO OUTPUTs to your amp's analog CD inputs.

Notes:

- RCA/phono audio cables are usually color coded: red and white. Use red plugs to connect right-channel inputs and outputs, and use white plugs to connect left-channel inputs and outputs.
- Push each plug in all the way to make a good connection (loose connections can cause noise or malfunctions).

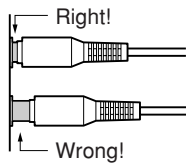

- To prevent interference, keep audio cables away from power cords and speaker cables.

DIGITAL AUDIO OUTPUT

If your CD-R, MiniDisc, or DAT recorder has a digital input, use a commercially available coaxial or optical fiber digital audio cable to connect the DX-7555's COAXIAL or OPTICAL DIGITAL AUDIO OUTPUT to your recorder.

You can also use the digital outputs to connect to an amp that has a digital input.

Note:

The OPTICAL DIGITAL AUDIO OUTPUT has a dust cap for keeping out dust and dirt when it's not in use. Remove the cap before connecting an optical fiber cable. Push the plug in all the way to make a good connection. Keep the dust cap in a safe place for future use.

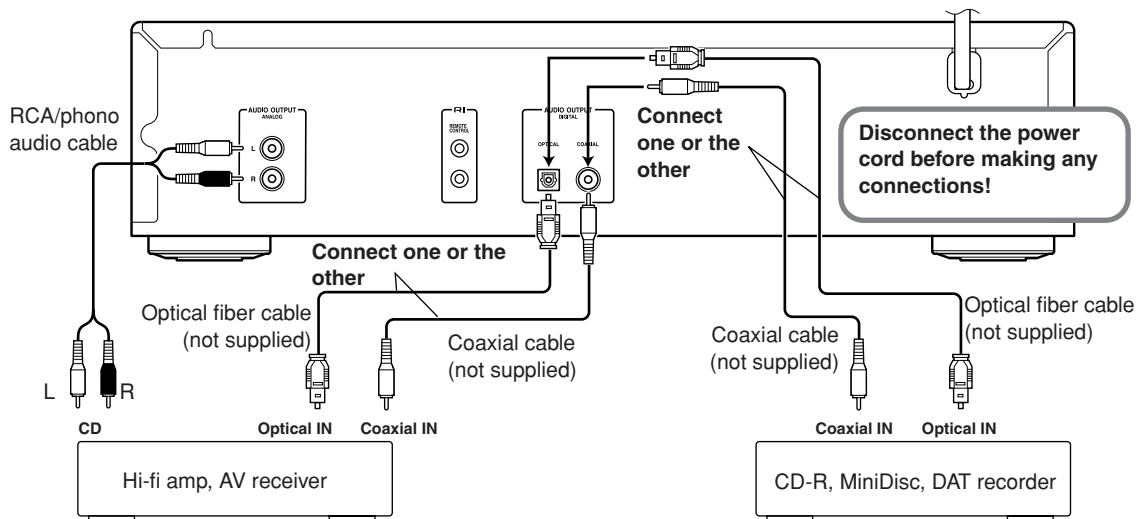
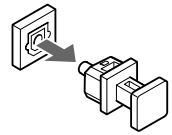

RI Connections

With **RI** (Remote Interactive) you can control the DX-7555 together with your other **RI**-compatible Onkyo AV components. With some Onkyo AV receivers you can use one remote controller to control all your Onkyo components and use the following special **RI** functions:

■ Auto Power On

If your DX-7555 is connected to an **RI**-compatible Onkyo hi-fi amp or AV receiver, when you turn on the DX-7555, the AV receiver will turn on and select the DX-7555 as the input source.

■ Direct Change

If your DX-7555 is connected to an **RI**-compatible Onkyo hi-fi amp or AV receiver, when you start playback on the DX-7555, the AV receiver will select the DX-7555 as the input source.

■ Dimmer

When you dim the display brightness on an **RI**-compatible Onkyo AV component, the displays on all other AV components connected via **RI** are dimmed as well.

To use the **RI** functions, you need to connect one of the DX-7555's **RI** connectors to an **RI** connector on another AV component in your system by using the supplied **RI** cable.

See the manuals supplied with your other **RI**-compatible AV components for more information.

Notes:

- Use only **RI** cables for **RI** connections.
- **To use RI you must make an analog RCA/phono connection between your DX-7555 and Onkyo AV receiver even if they are connected digitally.**
- The DX-7555 has two **RI** connectors. You can connect either one to your Onkyo hi-fi amp or AV receiver. The other connector is for connecting additional **RI**-compatible components.
- Connect the DX-7555's **RI** connector to only Onkyo AV components. Connecting to other manufacturer's AV components may cause them to malfunction.
- Some Onkyo **RI**-compatible AV components may not support the special functions described here.



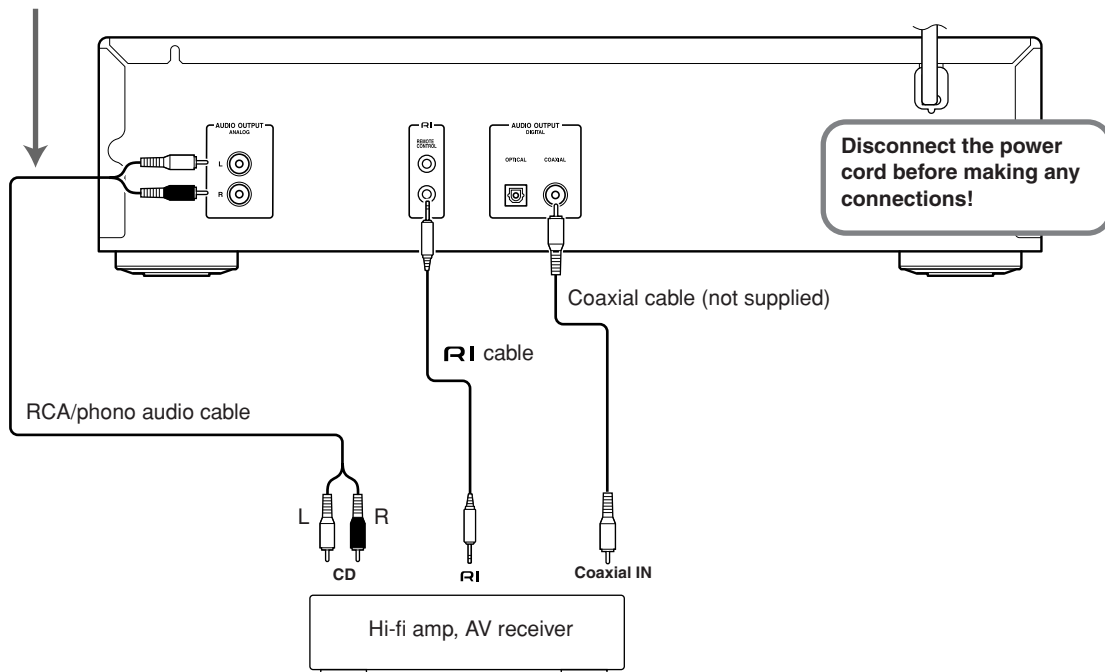



To use RI you must make an analog audio connection (RCA/phono) between the DX-7555 and your other Onkyo equipment even if they are connected digitally.

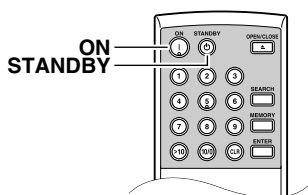
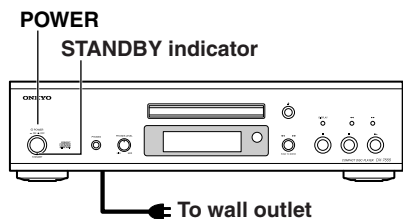

Turning On the DX-7555

Turning On the DX-7555









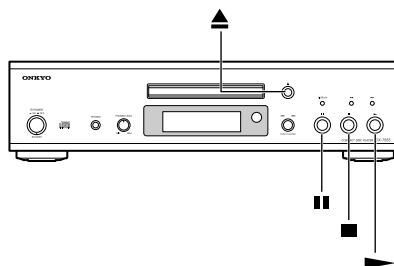

1	<p>Plug the power cord into a suitable wall outlet.</p>
<p>2</p> 	<p>Press the DX-7555's [POWER] switch. Make sure the switch is set to ON .</p>
<p>3</p> <p>Remote controller STANDBY</p>  <p>ON</p> 	<p>To put the DX-7555 on standby, press the STANDBY button on the remote controller while the DX-7555 is powered on. You will see the STANDBY indicator light up.</p> <p>To turn on the DX-7555 from its standby mode, press the ON button on the remote controller.</p>
<p>4</p> 	<p>Press again the switch to turn off the DX-7555. Make sure the switch is set to OFF .</p>

After power is supplied by turning on the switch:
If you turn off the POWER switch while power is supplied, the DX-7555 will be powered next time you turn on the POWER switch.
If you turn off the POWER switch during Standby mode, the DX-7555 will be put on standby next time you turn on the POWER switch.

Playing CDs



Playing CDs

1	<p>To open the disc tray, press the Open/Close [] button.</p> 
2	<p>Put the CD on the tray with the label side facing up. Be sure to put 8-cm discs in the center of the tray.</p> <p>Label side</p> 
3	<p>To close the tray, press the Open/Close [] button again.</p> 
4	<p>Press the Play [] button to start playback. Playback starts and the Play  indicator appears on the display.</p> <p>Note: With CDs that contain many tracks, playback may take a while to start.</p> 

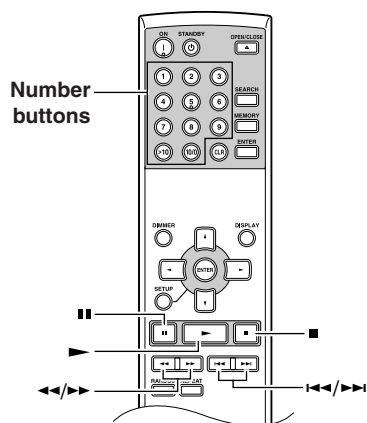
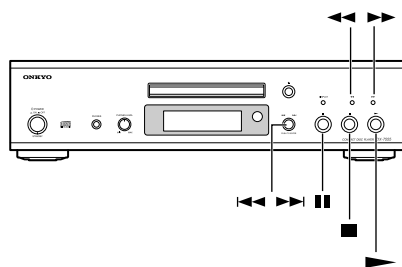

■ To Select Tracks by Number (Operating with remote controller only)

Use the number buttons to select specific tracks.

Use the [>10] button to enter track numbers above 10.

For example, to enter track number 10, press [10/0].

To enter track number 12, press [>10], [1], and [2].

To select MP3 tracks by number, see “Selecting MP3 Folders & Tracks by Number” on page 15.

■ To Stop Playback

Press the Stop [■] button.

■ To Pause Playback

Press the Pause [▬▬] button. The Pause [▬▬] indicator appears.

To resume playback, press the Play [▶] or Pause [▬▬] button again.

■ To Fast Forward or Fast Reverse

During playback or while playback is paused, press and hold the [▶▶] button to fast forward or the [◀◀] button to fast reverse.

You can also perform the same operation by using the [◀◀]/[▶▶] buttons on the remote controller.

Note:

For MP3 discs, fast reverse only works within the MP3 track that's currently playing.



■ To Select Tracks

Press the [▶▶] button to select the next track or the [◀◀] button to select the previous track.

- If you press the [◀◀] button during playback or while playback is paused, the beginning of the current track is selected.
- If you select a track while playback is stopped, press the Play [▶] button to start playback.
- You can select a next or previous track by using the [◀◀/▶▶] dial on the DX-7555.
- Press the [▲/▼] buttons on the remote controller to select a track, and then the ENTER button to start playback.





■ **Selecting MP3 Tracks**

You don't have to navigate the folder hierarchy to find an MP3 track because all folders that contain MP3 tracks appear at the same level. This mode can be used during playback and while playback is stopped.

<p>1</p>  <p>Remote controller</p>	<p>To select a track for playback</p> <p>You can select a track by rotating the [◀◀/▶▶] dial.</p> <p>You can select a track contained in any other folders.</p> <p>During playback, you can also have control by using the [▲/▼] buttons on the remote controller.</p>
<p>2</p>  <p>Remote controller</p>	<p>If you press the [◀◀/▶▶] dial, or the ENTER button on the remote controller, playback will start for the track.</p> <p>You can also perform the same operation by using the Play [▶] button.</p> <p>If you press [◀◀/▶▶] dial during playback, the next track will start to play.</p>

■ **Selecting MP3 Tracks in Group Mode**

In Group Mode, a folder must be selected before you can select a MP3 track.

<p>1</p>  <p>Remote controller</p>	<p>While playback is stopped, press the [◀◀/▶▶] dial.</p> <p>The first folder will be displayed.</p>  <p>When JOG MODE is set to NAVI in the SETUP menu, keeping the [◀◀/▶▶] dial pressed will put the DX-7555 into Group mode (see page 21).</p>
<p>2</p>  <p>Remote controller</p>	<p>Select a folder in which your target track is stored, and then select the track.</p>  <p>If you rotate the [◀◀/▶▶] dial, or press the [▲/▼] buttons on the remote controller, the folders contained in the disc will be displayed in sequential order.</p> <p>If you press the [◀◀/▶▶] dial, or the ENTER button on the remote controller, the first track in the folder will be displayed. And if you rotate the [◀◀/▶▶] dial, or press the [▶] button on the remote controller, the tracks contained in the folder will be displayed in sequential order.</p> <p>To go back to the previous hierarchy, press the Stop [■] button on the DX-7555, or the [◀] button on the remote controller.</p>
<p>3</p>  <p>Remote controller</p>	<p>If you press the [◀◀/▶▶] dial, or the ENTER button on the remote controller, playback will start for the track.</p> <p>You can also perform the same operation by using the Play [▶] button.</p>

■ To Select MP3 Tracks in Navigation Mode

With Navigation mode you can select MP3 tracks by navigating through the folder hierarchy. This mode can only be used while playback is stopped.

1



While playback is stopped, press and hold [◀▶] dial.

The DX-7555 enters Navigation mode and “[ROOT]” appears on the display.



When JOG MODE is set to NAVI in the SETUP menu, pressing the [◀▶] dial will put the DX-7555 into Navigation mode (see page 21). You can also change to Navigation mode by pressing [▲▼/◀▶] buttons or the ENTER button on the remote controller.

2



Remote controller



Press the [◀▶] dial once more, or press the [▶] button on the remote controller.

The name of the first folder one level down from root appears on the display.

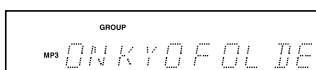

If the disc has no folders, the name of the first track is displayed.

- You can select a folder or track existing in a same hierarchy by rotating the [◀▶] dial, or pressing the [▲▼] buttons on the remote controller.
- Pressing the [◀▶] dial, or the [▲▼] buttons on the remote controller, while selecting a folder, you can go down by one hierarchy; and go one hierarchy up by pressing the [■] button on the DX-7555, or the [◀] button on the remote controller.

3



Remote controller



If you press the [◀▶] dial, or the ENTER button on the remote controller, while a track is selected, playback will start for the track.

You can perform the same operation by using the Play [▶] button.

Tip:

If you press the Play [▶] button while a folder is selected, playback start with the first track in that folder.

Selecting MP3 Folders & Tracks by Number

This section explains how to select MP3 folders and tracks by number.

1

Remote controller



While playback is stopped, press the [SEARCH] button.

“–” appears below the GROUP indicator on the display.

You can also perform the same operation by pressing the [>10] button repeatedly.



If the disc contains ten or more folders, “– –” appears.

2

Remote controller



Use the number buttons to enter the folder number.

Enter the numbers in order from left-to-right. For example, to enter folder number 25, press [2] and then [5].

The name of the specified folder appears on the display.

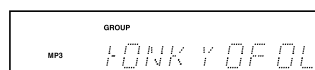

3

Remote controller



Press the ENTER button when the target playback group (folder) is displayed.

4

Remote controller



Use the number buttons to enter the track number.

Playback starts automatically.

If the folder contains 100 or more tracks, follow the steps described here to select tracks. For example, to enter track number 32, press [>10], [10/0], [3], and then [2]. To enter track number 132, press [>10], [1], [3], and then [2].

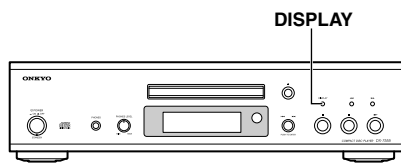

Displaying Information

This section explains how to display various information, including the remaining track time, remaining disc time, disc name, track name, and various ID3 tags for MP3 tracks, including title name, artist name, and so on.



During playback, press the [DISPLAY] button repeatedly to cycle through the following options.

■ Audio CD

Elapsed track time: The length of time that the current track has been playing (default display).

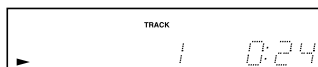

Remaining track time: The amount of time remaining for the current track (REMAIN indicator appears).



Remaining disc time: The amount of time remaining for the entire disc (REMAIN and TOTAL indicators appear).



During normal playback

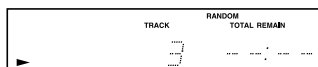

During random playback

■ MP3 Disc

Elapsed track time: The length of time that the current track has been playing (default display).

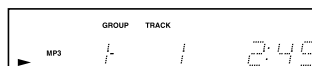

Track name: Name of the current track.

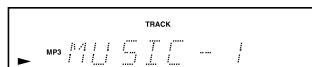

Group (folder) name: Name of the current group (folder).

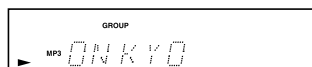

Title name: Title of the current track (if ID3 tag present).

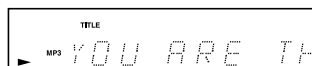

Artist name: Name of the artist (if ID3 tag present).

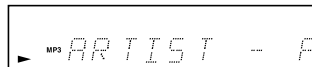

Album name: Name of the album (if ID3 tag present).

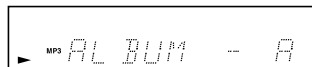

Sampling rate and bit rate: Sampling rate and bit rate of the current track.

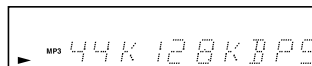

Notes:

- To display the disc name, while playback is stopped, press the [DISPLAY] button.
- If a track or folder name contains a character that cannot be displayed, it will be displayed as “TRACK n” or “GROUP n,” “n” being the track or folder number. You can set the DX-7555 so that it displays underscores in place of any undisplayable characters (see page 21).

■ To View the Reserved Memory

1



Press the Stop [■] button to stop playback.

Now you can view the reserved memory by pressing the [◀/▶] buttons. Press the STOP button to finish viewing.

■ To Stop Memory Playback

Press the Stop [■] button.

■ To Remove the Last Track from the Program

While memory playback is stopped, press the [CLEAR] button. Each time you press it the last track from the program will be removed.

■ To Cancel Memory Playback

Press the [MEMORY] button so that the MEMORY indicator disappears. The program will be deleted.

■ To Perform Memory Playback for Only One Track or Folder (for MP3 disc only)

<To Perform Memory Playback for Only One Track>

1

Play back the track for which you want to perform memory playback.

For information about how to select tracks, see pages 13-15.

2



Press the MEMORY button repeatedly until the MEMORY indicator lights up and the “MEMORY-TRK” is displayed.

<To Perform Memory Playback for Only One Folder (for MP3 disc only)>

1

Play back the track contained in a folder for which you want to perform memory playback.

For information about how to select folders and tracks, see pages 14-15.

2



Press the MEMORY button repeatedly until the MEMORY indicator lights up and the “MEMORY-GRP” is displayed.

You can select tracks to be played back by using the number buttons on the remote controller.

Random Playback

With the Random function, you can play tracks in random order.

1



Press the [RANDOM] button.

The RANDOM indicator appears on the display and random playback starts.

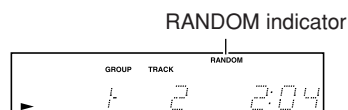

2



To cancel random playback, stop playback, or press the [RANDOM] button so that the RANDOM indicator disappears.

Note:

During random playback, pressing the [◀] button will not select the previous track.

Memory Random Playback

If you specify the pre-programmed tracks and press the RANDOM button, the random playback will start for the pre-programmed tracks only.

Repeat Playback

With the Repeat function, you can play all tracks repeatedly.

1



Press the remote controller's [REPEAT] button.

The Repeat indicator appears on the display and all tracks are played repeatedly.

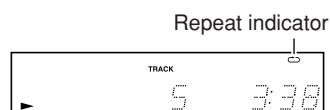

2



To cancel repeat playback, press the [REPEAT] button again.

The Repeat indicator disappears.

Repeat Memory Playback

If you press the [REPEAT] button during memory playback, the custom program will play repeatedly.

Repeat Random Playback

If you press the [REPEAT] button during random playback, tracks will be played in random order repeatedly.





Various Settings

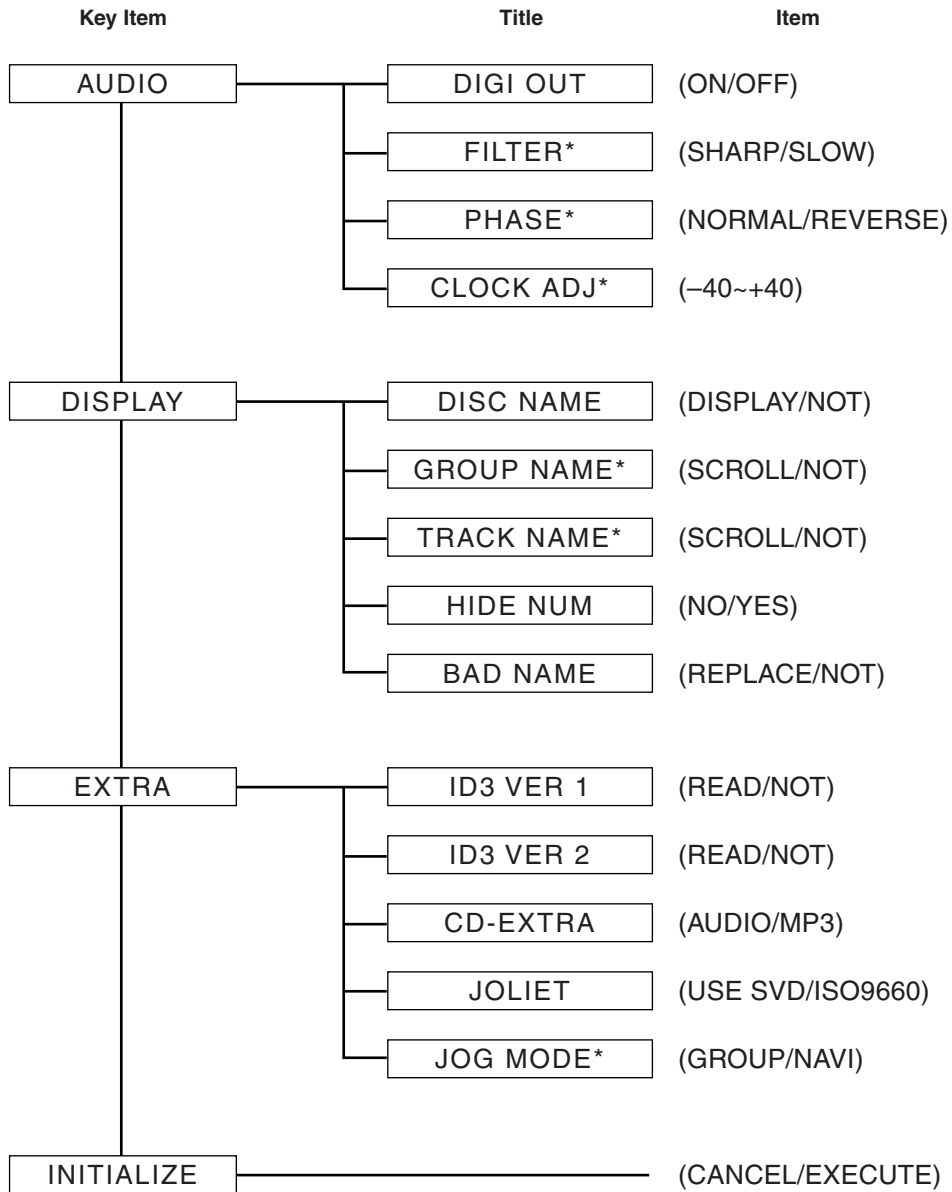

You can configure operating conditions of the DX-7555 for sound, display and MP3 disc.

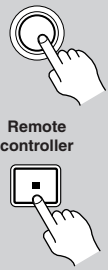
The Structure of the SETUP MENU

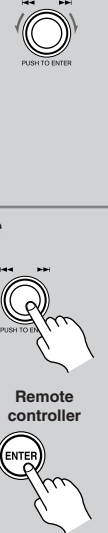

The operation marked with * can be performed even during playback or memory mode.

<p>1</p>  <p>Remote controller</p>	<p>Stop playback.</p> <ul style="list-style-type: none"> The numbers of all the groups (folders) and the tracks should be indicated on the display. The memory mode should be deselected.
<p>2</p>  <p>Remote controller SETUP</p>	<p>Press and hold the STOP button until “SETUP MENU” appears on the display (about a few seconds).</p> <p>When using the remote controller, press the SETUP button.</p>
<p>3</p>  <p>Remote controller ENTER</p>	<p>Rotate the [◀/▶] dial in a direction of clockwise or counterclockwise to display a key item, and then press the [◀/▶] dial.</p> <p>When using the remote controller, press the [▲/▼] buttons and then ENTER button.</p>
<p>4</p>  <p>Remote controller ENTER</p>	<p>Rotate the [◀/▶] dial in a direction of clockwise or counterclockwise to display a title you want to set, and then press the [◀/▶] dial.</p> <p>When using the remote controller, press the [▲/▼] buttons and then ENTER button.</p> <p>To return to the key item display, press the [■] button. When using the remote controller, press the [◀] cursor button.</p>

<p>5</p>  <p>Remote controller ENTER</p>	<p>Rotate the [◀/▶] dial in a direction of clockwise or counterclockwise to select an item.</p> <p>When using the remote controller, press the [▲/▼] buttons. Now the displayed item has been set. To return to the title display, press the [■] button. When using the remote controller, press the [◀] cursor button.</p>
<p>6</p>  <p>Remote controller ENTER</p>	<p>Exit the configuration.</p> <p>Press the [◀/▶] dial.</p> <p>When using the remote controller, press the ENTER or SETUP button.</p>

AUDIO

DIGI OUT (ON/OFF)

This preference configures the setting to switch the digital output on and off.

While listening to an analog source, you are recommended to turn off the digital output for better sound quality.

FILTER (Switching Digital Filter Characteristics)*

This preference configures the setting to switch the characteristics of the digital filter for D/A conversion. You can opt for whichever of the characteristics that vary depending on your switching.

SHARP (Sharp Roll-off Characteristics)

This preference allows the band property up to 20 kHz to be output almost flat.

SLOW (Slow Roll-off Characteristics)

This preference brings higher reproducibility of input waveform, and is suitable to reproduce agogics, or subtle attack of sound signals, along with sound image localization for each musical instrument.

Notes:

- The preference is valid for analog output only.
- If any preference produces no distinctive effect, use the DX-7555 with the factory default setting (SHARP).

PHASE (Switching Analog Output Phase)*

This preference configures the setting to switch the phase of the audio output.

You may give it a try to switch and listen so that an optimum sound quality can be obtained from the amplifier and the speakers on line.

NORMAL (Normal Phase)

The waveform recorded in CD disc will be output with its polarity left intact.

REVERSE (Reversed Phase)

The waveform recorded in CD disc will be output with its reversed polarity.

Notes:

- The preference is valid for analog output only.
- If any preference produces no distinctive effect, use the DX-7555 with the factory default setting (NORMAL).

CLOCK ADJ (Clock Adjustment)*

This preference configures the setting to fine adjust the clock on which the audio processing is based.

Normally, you may use the DX-7555 with a value of 0 (factory default setting).

Depending on the disc you use, you may hear slurred or unclear sound, in other word a sound image may be blurred. In such cases, you can obtain a clear sound image, or acoustic field, by adjusting the clock.

Give it a try to fine adjust the clock, while listening the playback, and then set your preference.

+ xx:

The clock frequency increases relative to the factory default setting.

– yy:

The clock frequency decreases relative to the factory default setting.

Notes:

- You can adjust in an approximate range between +40 and –40.
- If any adjustment produces no distinctive effect, use the DX-7555 with the factory default setting (0).

DISPLAY

DISC NAME (DISPLAY/NOT)

This preference determines whether or not the disc name is displayed when an MP3 disc is read.

GROUP NAME (SCROLL/NOT)*

This preference determines whether or not the group (folder) name scrolls across the display when an MP3 group (folder) is selected.

TRACK NAME (SCROLL/NOT)*

This preference determines whether or not the track name scrolls across the display when an MP3 track is selected.

HIDE NUM (NO/YES)

This preference determines whether or not a numeric character is displayed, if it is contained in the head of the track name and the group (folder) name.

BAD NAME (REPLACE/NOT)

This preference determines whether or not track and folder names that contain undisplayable characters are replaced with “TRACK n” or “GROUP n,” “n” being the track or folder number. When set to NOT, displayable characters are displayed and underscores are used in place of any undisplayable characters.

For ID3 tags, underscores are used in place of undisplayable characters regardless of this preference.

Note:

Track and folder names are scrolled in Navigation mode (page 15) regardless of the TRACK NAME and GROUP NAME preferences.

Extra Items

ID3 VER 1 (READ/NOT)

This preference determines whether or not version 1.0/1.1 tags are read and displayed. When set to NOT READ, version 1.0/1.1 tags will not be displayed.

ID3 VER 2 (READ/NOT)

This preference determines whether or not version 2.3/2.4 tags are read and displayed. When set to NOT READ, version 2.3/2.4 ID3 tags will not be displayed.

CD-EXTRA (AUDIO/MP3)

This preference applies to CD Extra discs and determines whether music in the audio session or MP3 tracks in the data session are played.

JOLIET (USE SVD/ISO9660)

This preference applies to MP3 discs in Joliet format and determines whether the DX-7555 reads the SVD data or treats the disc as an ISO 9660 disc. Normally, this preference doesn't need to be changed.

SVD (Supplementary Volume Descriptor) supports long file and folder names and characters other than letters and numbers. Some CD burning software refers to the Joliet format as “Windows format.”

JOG MODE (GROUP/NAVI)*

This preference configures the setting to switch the search method you want to apply to MP3 CD, by pressing the [◀◀/▶▶] dial.

In GROUP, you can change to Group mode by pressing the [◀◀/▶▶] dial, and to Navigation mode by keeping it pressed.





Similarly in NAVI, you can change to Navigation mode by pressing the [◀◀/▶▶] dial, and to Group mode by keeping it pressed (see pages 14-15).

INITIALIZE (CANCEL/EXECUTE)

This preference configures the setting to return each setting to the factory default state.

The operation marked with * can be performed even during playback or memory mode.

To Return Each Setting to the Factory Default

<p>1</p>  <p>Remote controller</p>	<p>Stop playback.</p> <ul style="list-style-type: none"> • The numbers of all the groups (folders) and the tracks should be indicated on the display. • The memory mode should be deselected.
<p>2</p>  <p>Remote controller SETUP</p>	<p>Press and hold the STOP button until “SETUP MENU” appears on the display (about a few seconds).</p> <p>When using the remote controller, press the SETUP button.</p>
<p>3</p>  <p>Remote controller</p>	<p>Rotate the [◀▶] dial in a direction of clockwise or counterclockwise to display [INITIALIZE], and then press the [◀▶] dial.</p> <p>When using the remote controller, press the [▲/▼] buttons and then the ENTER button.</p>
<p>4</p>  <p>Remote controller</p>	<p>Rotate the [◀▶] dial in a direction of clockwise or counterclockwise to display [EXECUTE].</p> <p>When using the remote controller, press the [▲/▼] buttons and then the ENTER button.</p> <p>To abort the INITIALIZE operation, display [CANCEL].</p>

5

Press the [◀▶] dial.

When using the remote controller, press the ENTER button.

If a disc is loaded, the DX-7555 will start reading the disc from scratch.



Remote controller

About CDs

Handling CDs

- Carefully lift the disc from its case, making sure to hold it by its edges or center hole.

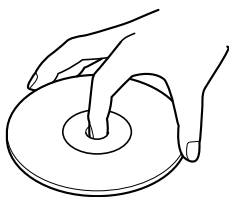

- You can use a soft, dry cloth to wipe dust and fingerprints off the surface of CDs. Do not use volatile agents, such as thinner or benzene. Don't use vinyl record cleaners or antistatic agents.

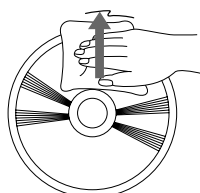

Notes:

- Don't keep a CD in direct sunlight or in locations subject to high humidity or low temperature.
- Don't leave a CD in the unit for a long period of time.

Supported Discs

The DX-7555 supports the following discs.

Disc	Logo	Format or file type
Audio CD		PCM
CD-R		Audio CD, MP3
		MP3
CD-RW		Audio CD, MP3
		MP3
CD Extra		Audio CD (Session 1), MP3 (Session 2)

- Some audio CDs use copy protection that doesn't conform to the official CD standard. Since these are non-standard discs, they may not play properly in the DX-7555.
- The DX-7555 supports CD-R and CD-RW discs. However, some CD-R and CD-RW discs may not work properly for any of the following reasons: disc burner characteristics, disc characteristics, the disc is damaged or dirty. See the manual supplied with your disc burner for more information. Condensation or dirt on the optical pickup lens can also affect playback.
- The DX-7555 supports 8 cm and 12 cm discs.

- If you load any other non-supported discs for reading or playback purpose, they may cause noise or not operate normally.
- The DX-7555 does not support disc types not listed.
- Don't use discs with an unusual shape, such as those shown below, because you may damage the DX-7555.



- Don't use discs that have residue from adhesive tape, rental discs with peeling labels, or discs with custom-made labels or stickers. Doing so may damage the DX-7555 and you may not be able to remove the disc properly.

Discs Made on Personal Computers

Discs made on personal computers, including those of a compatible format, may not work properly in the DX-7555 because of incorrect settings in the disc burning software. Check the manuals supplied with your disc burning software for additional compatibility information.

MP3 Compatibility

- MP3 discs must be ISO 9660 Level 1 or Level 2, Romeo or Joliet compliant. Supported formats: Mode 1, Mode 2 XA Form 1.
- Folders can be up to eight levels deep.
- MP3 files must be MPEG-1/MPEG-2 Audio Layer 3 format with a sampling rate of between 8 kHz and 48 kHz and a bit-rate of between 8 kbps and 320 kbps (128 kbps recommended). Incompatible files cannot be played.
- Constant bit rate MP3 files are recommended, however, variable bit rate (VBR) MP3 files between 8 kbps and 320 kbps are supported. (Playing times may display incorrectly.)
- MP3 files must have a ".mp3" or ".MP3" file name extension. MP3 files without the proper extension will not be recognized. To prevent noise and malfunction, do not use these extensions for other types of files.
- The DX-7555 supports up to 499 total tracks including the folders of a disc and the MP3 files, however, the maximum number of folders may not exceed 99. Files and folders in excess of this cannot be played. Note that if the file and folder structure is very complicated, the DX-7555 may not be able to read or play all of the MP3 files on the disc.
- Disc, file and folder names may contain up to 32 characters.
- The maximum time that can be displayed for a single track is 99 minutes and 59 seconds.
- The remaining time cannot be displayed when playing MP3 files.

About CDs—Continued

- MP3 file and folder names (excluding the extension) are shown on the display.
- The emphasis is not supported.
- Multisession discs are supported, however, some multisession discs may take a long time to load and some may not load at all. When burning CDs we recommend that you use a single-session (disc-at-once), and select “Disc Close.”
- Normally, the music in the audio session of a CD Extra disc is played. However, you can set the DX-7555 so that it plays any MP3 files in the data session of a CD-R/RW disc instead. If the data session contains no MP3 tracks, the audio session will be played regardless.
- The following ID3 tags are supported: versions 1.0/1.1 and 2.2/2.3/2.4. Version 2.5 and later are not supported. Normally, version 2.2/2.3/2.4 tags have priority and will be displayed regardless of the ID3 VER 1 preference on page 21.
- For ID3 version 2 tags, information contained in the beginning of the file are recognized. We recommend that you include only title, artist name, and album name information in ID3 tags. Compressed, encrypted, and unsynchronized ID3 tags cannot be displayed.
- Some MP3 files may have ID3 tags whose information can be displayed no longer than 31 characters.

Notes:

- With CD-ROM, CD-R, and CD-RW discs that contain many files and folders, and files other than MP3s, it may take a long time to read the disc. We recommend that you include only MP3 files on your discs, use about 20 folders, and limit folder nesting to three levels deep.
- **In this manual, MP3 files are referred to as *tracks*.**
- **Likewise, folders (directories) are referred to as *groups*.**

About Playing Copy-controlled CDs

Some copy-controlled CDs may not conform to the official CD standard. These special discs may not play properly on the DX-7555.

Don't load discs that are not audio discs (e.g., CD-ROMs designed for use with computers), as these may damage your speakers or amplifier.

Troubleshooting

If you have any trouble using the DX-7555, look for a solution here. If you can't resolve the issue yourself, contact your Onkyo dealer.

Power

Can't turn on the DX-7555.

- Make sure that the power cord is properly plugged into the wall outlet (page 12).
- Unplug the power cord from the wall outlet, wait five seconds or more, then plug it in again.
- While the DX-7555 is in Standby state, you can turn the power on by pressing the ON button on the remote controller.

Audio

There's no sound.

- The DX-7555 is not connected properly. Check all connections and correct as necessary.
- The wrong input source is selected on your amplifier. Check your amplifier's input source setting. Refer to your amplifier's manual.
- If the DIGI OUT is set to OFF in the SETUP menu, no digital audio output is available (page 20).

CD

Can't play a CD.

- The disc is upside down. Load the disc with the label-side facing up (page 12).
- The disc is dirty. Remove the disc and clean it (page 23).
- Condensation has formed inside the DX-7555. Remove the disc and leave the DX-7555 turned on for several hours until the condensation has evaporated.
- The disc is nonstandard. See "Supported Discs" on page 23.
- The CD-R/RW disc is nonstandard. See "Supported Discs" on page 23.

CD playback skips.

- Install the DX-7555 somewhere free of vibration.
- The disc is dirty. Remove the disc and clean it (page 23).
- The disc is very scratched. Replace the disc.

Can't enter track numbers for memory playback.

- No such track on the CD. Enter another number (page 17).

It takes a long time to locate certain tracks.

- The disc is dirty. Remove the disc and clean it (page 23).
- The disc is very scratched. Replace the disc.

SETUP

Can't find a SETUP menu in need.

- If any track has been selected even when the DX-7555 is stopped, you must place it into the full stop state by pressing the **[■]** button before you can view all the SETUP menus.

Remote Controller

The remote controller does not work.

- There are no batteries in the remote controller. Install new batteries (page 9).
- The batteries are flat. Replace with new batteries (page 9).
- The batteries are installed incorrectly. Check the batteries and correct as necessary (page 9).
- You're not pointing the remote controller at the DX-7555's remote sensor. Point the remote controller at the DX-7555's remote sensor (page 9).
- You're too far away from the DX-7555. Use the remote controller closer to the DX-7555 (page 9). The remote controller has a range of approximately 5 meters (16 ft.).
- A strong light source is interfering with the DX-7555's remote sensor. Make sure that the DX-7555 is not subjected to direct sunshine or inverter-type fluorescent lights. Relocate if necessary.
- If the DX-7555 is installed in a cabinet with colored glass doors, the remote controller may not work reliably when the doors are closed. Open the doors, or use a cabinet without colored glass.

Troubleshooting—Continued

RI does not work.

- There's no RCA/phono analog audio connection. To use **RI** you must make an analog audio connection (RCA/phono) between the DX-7555 and your Onkyo AV receiver, even if they are connected digitally.

■ **Meaning of Displayed Messages**

NO DISC:

No disc is loaded; otherwise disc reading has failed.

FULL:

An attempt was made to store more than 25 tracks in memory.

The DX-7555 contains a microcomputer for signal processing and control functions. In very rare situations, severe interference, noise from an external source, or static electricity may cause it to lockup. In the unlikely event that this should happen, unplug the power cord, wait at least 10 seconds, and then plug it again.

Onkyo is not responsible for damages (such as CD rental fees) due to unsuccessful recordings caused by the unit's malfunction. Before you record important data, make sure that the material will be recorded correctly.

Specifications

Signal readout:	Optical non-contact
Frequency response:	2 Hz–20 kHz
SN ratio:	111 dB
Audio dynamic range:	100 dB
THD (total harmonic distortion):	0.0027%
Audio output	
Digital optical:	–22.5 dBm
Audio output/Impedance	
Digital coaxial:	0.575 p-p, 75 Ω
Audio output/Impedance	
Analog:	2.0 V (rms), 470 Ω
Power supply:	AC 230-240 V, 50 Hz AC 220-230 V, 50/60 Hz AC 120 V, 60 Hz
Power consumption:	16 W/14 W
Standby power consumption:	European: 0.5 W North American: 0.3 W Others: 0.4 W/0.3 W
Dimensions (W × H × D):	435 × 111 × 405 mm
Weight:	8.0 kg
Operation condition	
Temperature, humidity:	5–35 °C, 5–85% (no condensation)
Supported discs:	CD, CD-R, CD-RW, MP3 (Discs that have not been properly finalized may only be partially playable or not playable at all.)

Specifications and features are subject to change without notice.

ONKYO CORPORATION

Sales & Product Planning Div. : 2-1, Nisshin-cho, Neyagawa-shi, OSAKA 572-8540, JAPAN
Tel: 072-831-8023 Fax: 072-831-8124

ONKYO U.S.A. CORPORATION

18 Park Way, Upper Saddle River, N.J. 07458, U.S.A.
Tel: 201-785-2600 Fax: 201-785-2650 <http://www.us.onkyo.com/>

ONKYO EUROPE ELECTRONICS GmbH

Liegnitzerstrasse 6, 82194 Groebenzell, GERMANY
Tel: +49-8142-4401-0 Fax: +49-8142-4401-555 <http://www.eu.onkyo.com/>

ONKYO EUROPE UK Office

Suite 1, Gregories Court, Gregories Road, Beaconsfield, Buckinghamshire, HP9 1HQ
UNITED KINGDOM Tel: +44-(0)1494-681515 Fax: +44(0)-1494-680452

ONKYO CHINA LIMITED

Unit 1 & 12, 9/F, Ever Gain Plaza Tower 1, 88, Container Port Road, Kwai Chung,
N.T., Hong Kong Tel: 852-2429-3118 Fax: 852-2428-9039
<http://www.ch.onkyo.com/>



D0607-2

SN 29344106A

(C) Copyright 2006 ONKYO CORPORATION Japan. All rights reserved.

