

ONKYO

TX-NR535

AV RECEIVER

Basic Manual

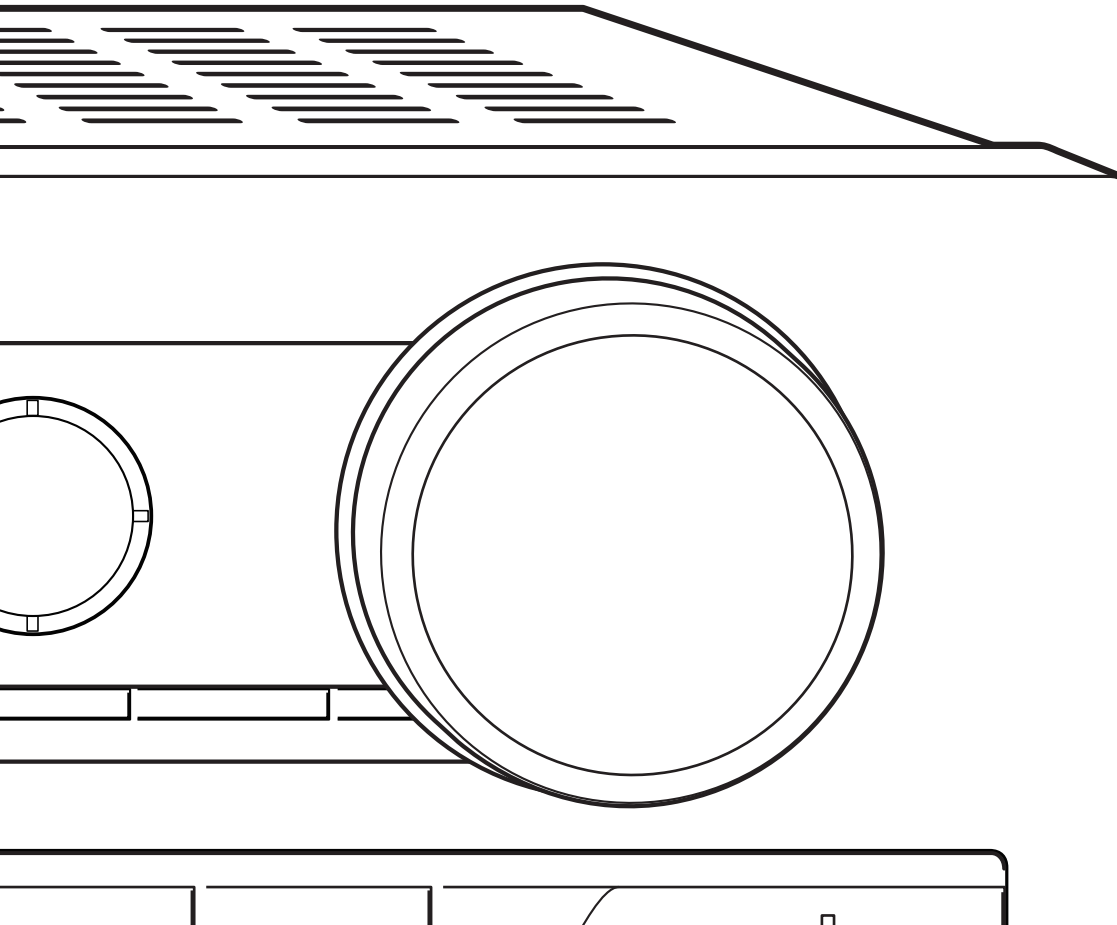

Advanced Manual found here



<http://www.onkyo.com/manual/txnr535/adv/en.html>

En

Before Start

About the Basic Manual

The Basic Manual leads you through the fundamental steps to enjoy the AV Receiver from connections to TV, speaker system and playback devices, to necessary functions for playback. As well as that, Basic Manual informs you with the instructions on frequently used functions. Besides, there is another part of the manual called Advanced Manual to inform you with more detailed information, which we have decided to publish on the web from the ecological point of view.

Advanced Manual

Advanced Manual is always updated with the latest information and its user friendly interface, which does not matter whether you access from PC or Smartphone, helps you to understand more deeply about the AV Receiver.

Advanced Manual is consisted of the following chapters.

- Details on AM/FM playback
- Playing Music Files on a USB Storage Device
- Listening to Internet Radio
- Playing Music with DLNA
- Playing Music Files in a Shared Folder
- Operating Music Files with the Remote Controller
- Using the Listening Modes
- Advanced Settings
- Operating Other Components with the Remote Controller
- Connecting/Operating Onkyo product with RI jack.
- Updating the Firmware
- Details on Troubleshooting
- Reference Information









Advanced Manual found here
<http://www.onkyo.com/manual/txnr535/adv/en.html>

Features

The unit is designed to be connected in between the TV and the playback devices such as Blu-ray disc player. Video signal from the playback devices will be sent through the unit to the TV and audio will be reproduced with the speakers creating Dolby Digital or other kind of surround sound field. The unit has many in/out jacks on its rear panel which allows you to connect a lot of playback devices simultaneously. Playback can be switched by selecting the input selector buttons. For playback of CEC compliant devices, input will be switched automatically.

- Equipped with 5 channel amplifier
- Equipped with 4K 60 Hz Passthrough-compatible HDMI IN/OUT jacks
- Supports the HDMI Through function which allows transmission from playback devices to the TV in standby state
- Supports ARC (Audio Return Channel)
- Supports USB storage playback
- Supports variety of network functions such as Internet Radio, DLNA, etc.
- Supports Wi-Fi and Bluetooth
- A/V Sync Control Function to correct deviation of audio and video
- Zone2 function which allows you to play a different source in another room from the main room
- T-D (Theater-Dimensional) listening mode which allows you to enjoy the virtual surround sound field
- 192 kHz/24 bit D/A converter
- Automatic speaker setup available using supplied calibrated microphone (AccuEQ Room Calibration)
- 32 bit DSP (Digital Signal Processor) with excellent calculation performance
- Supports playback of MP3, WMA, WMA Lossless, FLAC, WAV, Ogg Vorbis, Apple Lossless, DSD, Dolby TrueHD via network and USB storage device

Supplied Accessories

-  Indoor FM antenna --- (1)
-  AM loop antenna --- (1)
-  Color labels for speaker cable --- (1)
-  Remote controller (RC-879M) --- (1)
Batteries (AA/R6) --- (2)
-  Power cord (Taiwanese model) --- (1)
-  Speaker setup microphone --- (1)

The number in parenthesis indicates the quantity. On packaging, the letter at the end of the product name indicates the color.

Step 1: Connections

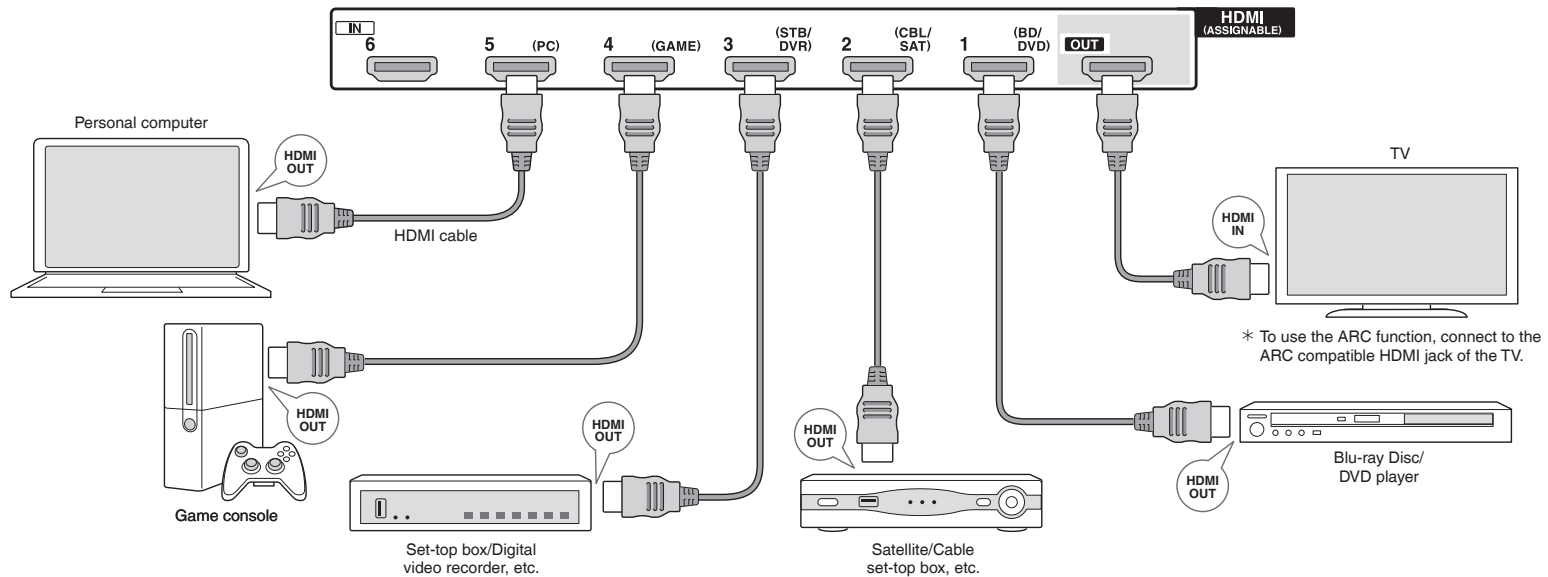

1 Connecting the TV and players

Important: The power cord must be connected only after all other connections are completed.

HDMI cable connection

The unit has many HDMI jacks on its rear panel and each of them corresponds to an input selector button of the same name on the front panel. For example, a Blu-ray Disc player will be connected to the IN 1 jack and the BD/DVD button on the front panel will be used to listen to the playback sound (if the player is CEC compliant, input will be switched automatically). If you add another Blu-ray Disc player, you can use any other jack than IN 1. It is possible to change assignment of the input jacks and input selector buttons. For how to make settings, see the Advanced Manual (<http://>

www.onkyo.com/manual/txnr535/adv/en.html).

To connect the TV and the unit, connect the HDMI OUT jack of the unit and the HDMI input jack of the TV with an HDMI cable. With this connection, it becomes possible to display the setting screen of the unit on the TV or transmit video/audio signals from the player to the TV. If your TV supports ARC (Audio Return Channel), it is possible to play the TV sound with the AV receiver's speakers with this connection only.

If your TV does not support ARC, you need, in addition to the HDMI OUT jack connection, a digital optical cable connection between the digital audio out optical jack of the TV and the DIGITAL IN OPTICAL jack of the unit or an analog audio cable connection between the audio output jack of the TV and the TV/CD analog audio input jack of the unit.

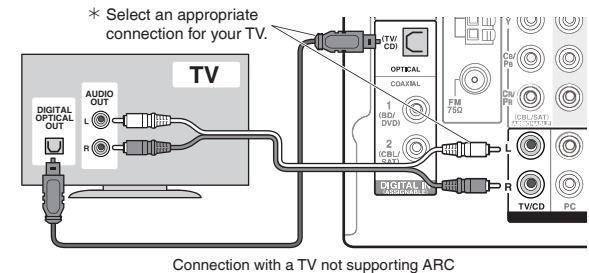

The unit supports the HDMI Through function that allows transmission from players to the TV even if the unit is in standby.

- It is necessary to make appropriate settings to enable the HDMI linked system function, ARC function and HDMI Through function. See the section 4 of "Step 2: Setting Up".

Connecting Components without HDMI

The video/audio jacks other than HDMI jacks also have a preassigned input selector button on the front panel. See the name of the input selector button shown with the jack when connecting the device. It is possible to change the assignment if necessary. For more information, see the Advanced Manual (<http://www.onkyo.com/manual/txnr535/adv/en.html>). Note that when connecting the player to the ② COMPONENT VIDEO IN jacks, you need to connect the TV to the ② COMPONENT VIDEO OUTPUT jacks. Also note that when connecting the player to the ③ composite video input jack, you need to connect the TV to the ④ MONITOR OUT jack.

- ① **DIGITAL IN jacks:** A player with a digital audio out optical jack or digital coaxial audio out jack can be connected. To enjoy digital surround sound including Dolby Digital and DTS, use one of these connections or the HDMI cable connection.
- ② **COMPONENT VIDEO jacks:** A TV with component video input jacks or a player with component video output jacks can be connected.
- ③ **VIDEO/AUDIO IN jacks:** A player with a composite video output jack or RCA audio output jacks can be connected.
- ④ **MONITOR OUT V jack:** A TV with a composite video input jack can be connected.

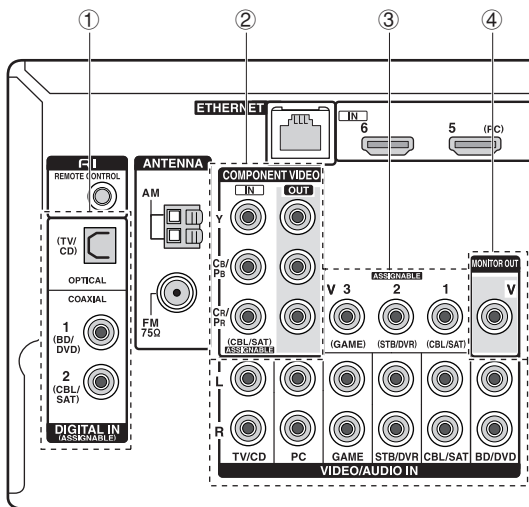

If the connected turntable does not have built-in audio equalizer, you need to install an external audio equalizer between the unit and the turntable. Contact the manufacturer for more information.

Type of cables

Video/audio transmission



HDMI cable: Enables digital transmission of video/audio signals and control signals between devices via single cable connection.
 * Use high speed HDMI cable when playing back 4K 1080p high definition video.

Audio transmission



Digital optical cable: Transmits digital audio. The audio quality is the same as that of the digital coaxial cable.
 * As the digital in optical jack of the unit has a cover, push in the cable against the cover as it is turned inside.



Digital coaxial cable: Transmits digital audio. The audio quality is the same as that of the digital optical cable.

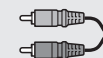

Analog audio (RCA) cable: Transmits analog audio signals.

Video transmission

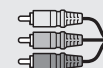

Component video cable: Transmits higher quality video signals than those of the composite video cable.



Composite video cable: Transmits analog video signals.

2 Connecting speakers

Important: The power cord must be connected only after all other connections are completed.

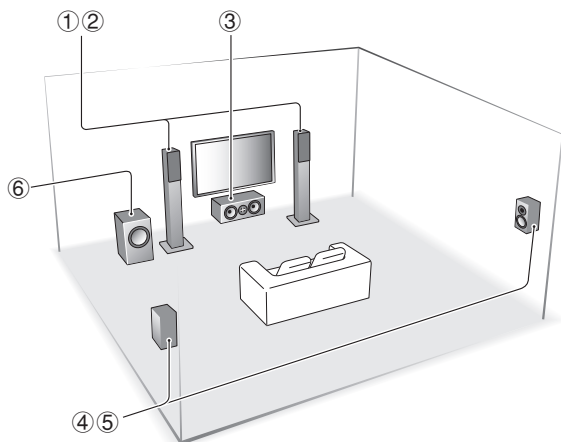

- ① ② Front speakers
- ③ Center speaker
- ④ ⑤ Surround speakers
- ⑥ Subwoofer

* Up to two subwoofers can be connected.

It is ideal to install the front speakers and center speaker at the height not too far from that of the screen. As for the surround speakers, it is recommended to install at the position slightly backward of the listening position and higher than the listener's ears, since it is preferable to obtain a diffused sound rather than a direct sound. As a bass sound reproduced by subwoofer is less directional, it is possible to place it at any position. Consider the best installation position where a bass sound can be clearly heard by listening to actual playback.

Connect speakers with 6 Ω to 16 Ω impedance. Using a speaker with less impedance than the supported value may result in failure.

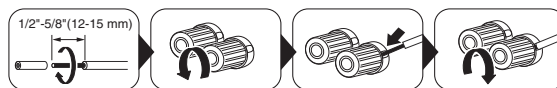
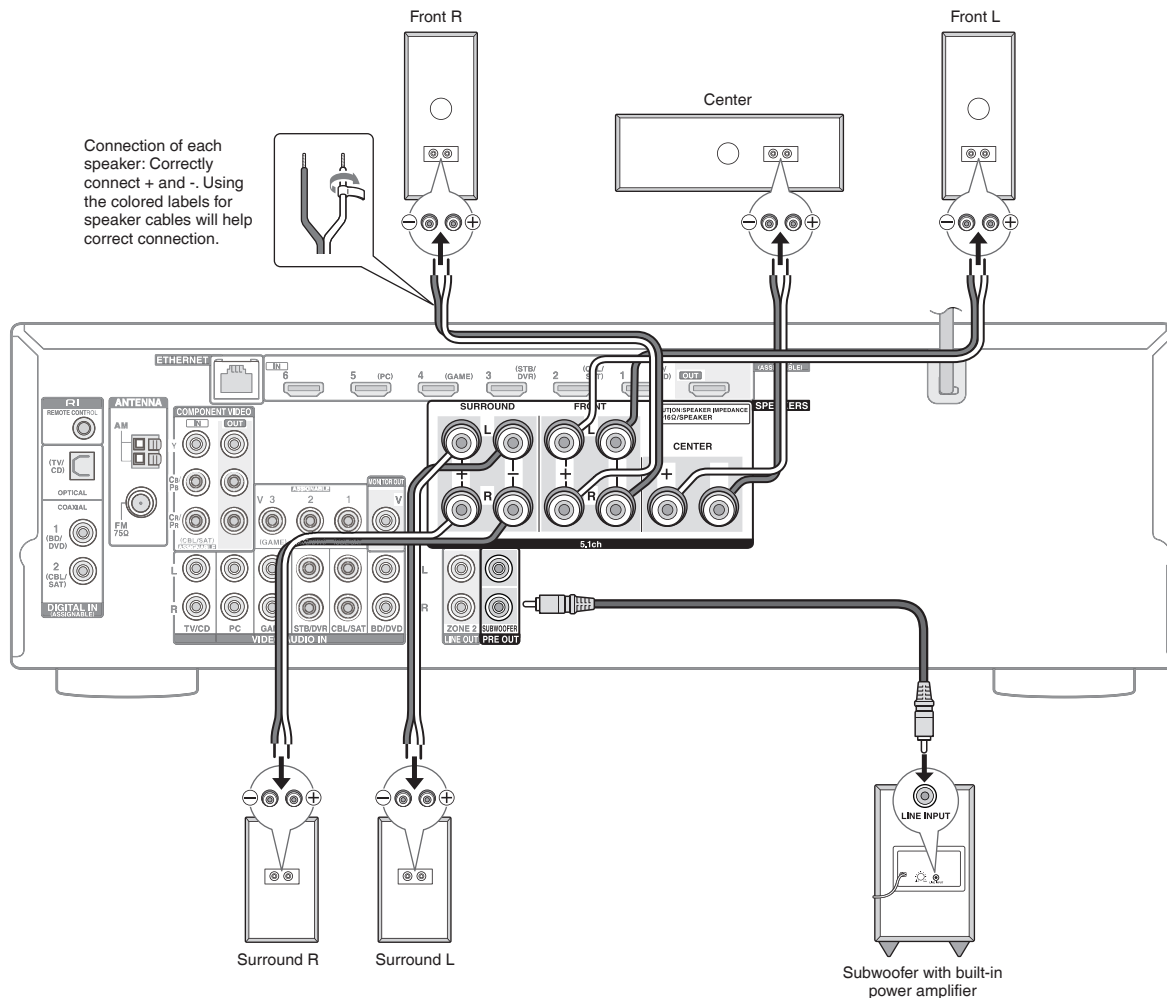

Cut and remove the plastic coating from the end of the speaker cable, twist the core and connect it to the terminal. Make correct connection between the unit's jacks and

speaker's jacks (+ to + and - to -) for each channel. If connection is wrong, a bass sound may become poor due to reverse phase. Attaching the supplied colored speaker cable

labels to the + side on the both ends of each channel's cable will help correct connection. The subwoofer jack supports connection of a subwoofer with built-in power amplifier. Set the cut-off filter selection switch of the subwoofer to DIRECT. If the subwoofer does not have a cut-off filter selection switch but has a cut-off frequency adjusting dial, turn it to the maximum frequency. If your subwoofer does not have built-in power amplifier, you can connect a power amplifier between the unit and the subwoofer.

- The speaker setting is 5.1 ch at the time of purchase. You can change it manually or by using automatic speaker setting.
- Short-circuiting the + cable and - cable or contacting the cable core to the rear panel of the unit may cause failure. Also do not connect two or more cables to one speaker jack or one speaker to several jacks.

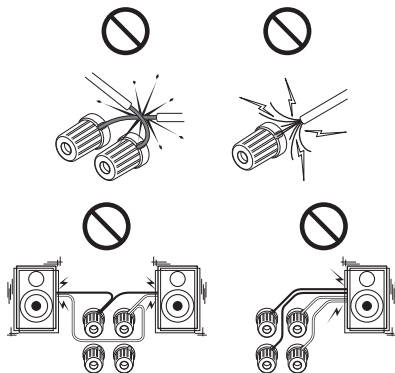

When using commercially available banana plugs: tighten the speaker terminals to the end and then insert the banana plugs. Do not insert the cable core directly into the center hole of the speaker terminal. (North American model)

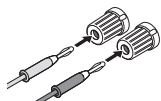

3 Other connections

AM/FM antenna connections

Connect the antennas to listen to AM/FM broadcast. When listening to the broadcast for the first time, adjust the antenna position and orientation to get the best reception.

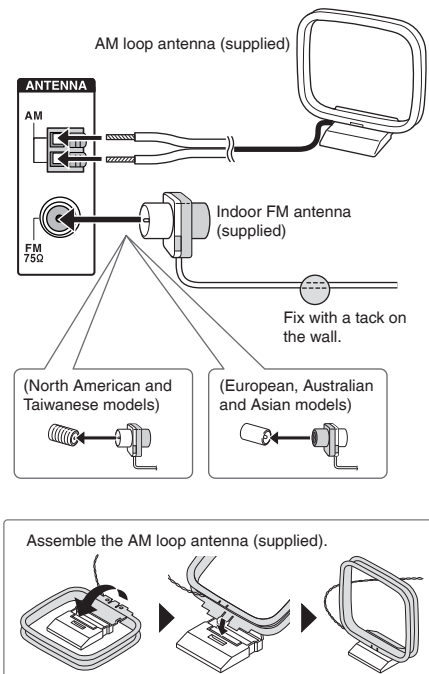

Network connection

You can enjoy Internet radio and DLNA by connecting the unit to LAN. The unit can be connected to the router with an Ethernet cable or to the wireless LAN router with Wi-Fi connection. In case of wired connection, connect the Ethernet cable to the Ethernet port. For Wi-Fi setup, see the section 3 of "Step 2: Setting Up".

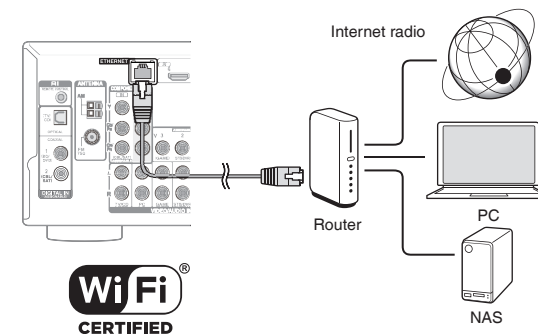

Headphones connection

Connect stereo headphones with a standard plug (1/4 inch or \varnothing 6.3 mm) to the PHONES jack. Sound from the speakers will be off while you are using the headphones.

- If you selected any other listening mode than Pure Audio (European, Australian and Asian models), Stereo, Mono and Direct, connecting headphones will switch the listening mode to Stereo.

Step 2: Setting Up

1 Turning the power on

Connect the power cord to the outlet (*). Press **ON/STANDBY** on the main unit or **RECEIVER** on the remote controller to turn the unit on or to standby mode.

- When the unit is turned on, a large instantaneous current may flow affecting functionality of the computer and other devices. It is recommended to use a separate outlet from that for the computer or such other sensitive devices.
 - * Taiwanese model includes a removable power cord. Connect the power cord to AC INLET of the unit and then connect to the outlet. Always disconnect the outlet side first when disconnecting the power cord.

Firmware update notification: If the unit is connected via LAN and there is firmware update available, the "Update New F/W" message will appear. Press the **▲/▼** buttons on the remote controller to select whether to update or not and press **ENTER** to confirm your selection. For details on firmware update, see the Advanced Manual (<http://www.onkyo.com/manual/txnr535/adv/en.html>).

2 Making automatic speaker setting

The AccuEQ Room Calibration function, our proprietary technology, collects the test tones coming from each speaker with the supplied speaker setup microphone and performs automatic setting of the number of speakers, volume level, each speaker's optimum crossover frequencies, and distance from the primary listening position. Distortion caused by difference of room acoustic environment will also be corrected to produce clear, well-balanced sound.

1. Place the speaker setup microphone at the measurement position ★.

- Correct measurement will not be possible if the microphone is held by hand. It is desirable that the microphone be placed on a stand at the height of listener's ears. Measurement is not possible if headphones are being used.

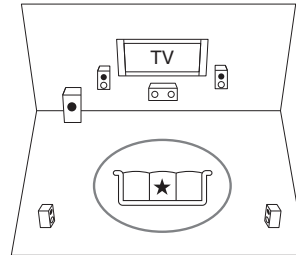

○ : Listening area

★ : Measurement position with microphone

2. Connect the speaker setup microphone to the SETUP MIC jack on the unit.

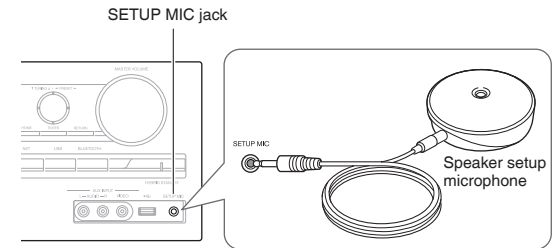

3. Follow the guidance displayed on the TV screen.

You can set up by viewing the guidance displayed on the TV screen. To display the guidance, you need to make HDMI connection between the unit and TV. Select the item with the cursor buttons of the remote controller and press **ENTER** to confirm your selection.

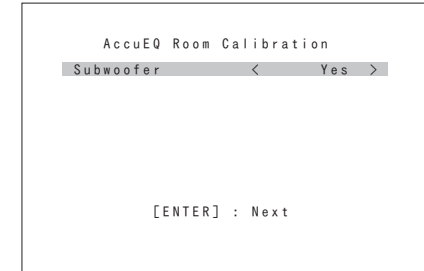

4. The test tones sound from the connected speaker and automatic speaker setting starts.

The microphone measures the test tones. Measurement will be made twice for each speaker. It takes several minutes to be completed.

- Each speaker generates test tones at high volume level during measurement. Keep the room as quite as possible during measurement. Measurement may be interrupted if there is ambient noise or radio frequency interference. Close the window and turn off the home appliance and fluorescent light.
- To cancel measurement on the way, disconnect the microphone plug.

5. When the measurement is completed, the measurement result is displayed.

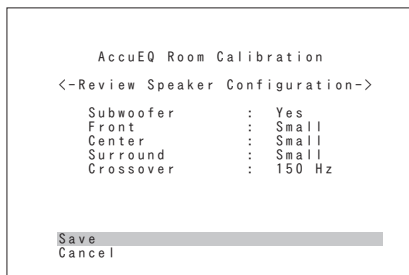

Press ◀▶ on the remote controller to check the settings. Pressing ENTER when "Save" is selected will save the settings.

- The subwoofer sound may not be detected since it is extremely low frequencies. If "No" is shown for "Subwoofer" in the measurement result screen, raise the subwoofer volume to around the half of its maximum volume and make its frequency to the maximum level.

6. On the screen showing "AccuEQ" is "On", press ENTER.

The settings will be applied to all the inputs.

7. When "Please unplug setup microphone." is displayed, disconnect the microphone.

- If you change the speaker positions, the room furniture layout or the number of speakers, perform automatic speaker setting again.
- If there is an error message, follow the on-screen instruction to remove the error cause.

3 Making Wi-Fi setting

Items to be checked before starting the procedure

Wi-Fi connection requires an access point such as wireless LAN router (*). Write down the SSID and password (key) of the access point if they are shown in the label of the main body. If the access point has an automatic setting button (may be called differently according to the manufacturer), you can set up without inputting the password. For how to use the automatic setting button of the access point, refer to its instruction manual.

* The unit supports Wi-Fi connection with 2.4 GHz access point.

- **Operation:** You can set up by viewing the guidance displayed on the TV screen. To display the guidance, you need to make HDMI connection between the unit and TV. Select the item with the cursor buttons of the remote controller and press ENTER to confirm your selection. To return to the previous screen, press RETURN.

1. Start "Wi-Fi Setup".

- ① Press RCV on the remote controller and then press HOME.
- ② Select "Setup" with the cursor buttons and press ENTER.
- ③ Select "12. Network Setup" with the cursor buttons and press ENTER.
 - "12. Network Setup" becomes selectable after the network starts up even if it cannot be selected first. It may take about a minute to start up.
- ④ Select "Wi-Fi" with the cursor buttons and select "On" to display "Wi-Fi Setup".
- ⑤ Select "Start" in "Wi-Fi Setup" with the cursor buttons and press ENTER.

2. Select the SSID of the access point to be connected with the cursor buttons and press ENTER.

When the SSID of the access point appears on the TV screen, select the desired access point.

- If you changed the initial setting of the access point to skip password entry, step 4 starts automatically.
- If you changed the initial setting of the access point to hide the SSID, see "When the access point is not displayed".

3. Select and set the authentication method.

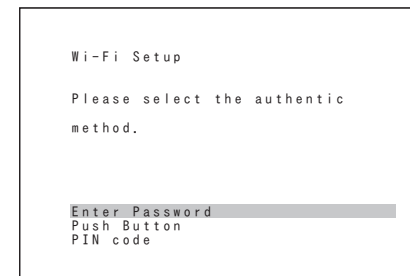

When the screen above is displayed, select and set one of the three authentication methods: "Enter Password", "Push Button" and "PIN code". See below for details of and how to set each method.

- **Enter Password:** Enter the password of the access point to establish connection.

- ① Select "Enter Password" with the cursor buttons and press ENTER.
- ② Enter the password (*) on the keyboard screen, select "OK" with the cursor buttons and press ENTER.
 - In some case, the key board screen is displayed automatically instead of authentication screen depending on access point device.

* To switch uppercase/lowercase, select "Shift" and press ENTER. Select "Left" or "Right" and press ENTER to move the cursor to the selected direction. Select "BS" and press ENTER to delete the character at the left of the cursor position. To select whether to mask the password with "*" or display it in plain text, press D on the remote control. Press + 10 on the remote controller to enable the "Shift" function and CLR to delete all the input characters.

- ③ If the security method of the access point to be connected is WEP, select "Default Key ID", select "OK" and press ENTER.

- **Push Button:** Use the automatic setting button of the access point to establish connection.

- ① Select "Push Button" with the cursor buttons and press ENTER.
- ② Hold down the automatic setting button of the access point for the necessary seconds, select "OK" with the cursor buttons and press ENTER.

4 HDMI Setup

■ **PIN code:** Select this method when the automatic setting button of the access point is beyond the reach. Select "PIN code" with the cursor buttons and press ENTER to display the 8-digit PIN code. Register the displayed PIN code to the access point, select "OK" with the cursor buttons and press ENTER. For how to register the PIN code to the access point, refer to its instruction manual.

4. Establish connection.

The connection process starts and the Wi-Fi indicator on the left of the unit's display starts flashing. When connection has been established, the Wi-Fi indicator changes from flashing to staying lit. If the Wi-Fi indicator does not stay lit, connection has not been established. Make the setting again. If "Push Button" does not work, try "Enter Password".

5. Enjoy Internet radio or other sources.

Press HOME on the remote controller and select "Network Service" in the Home menu. You can use a variety of Internet services.

When the access point is not displayed

Select "Other..." with ► on the remote controller and press ENTER to display the keyboard screen. Input the SSID and password. Make the following settings according to the router setting.

■ WPA/WPA2 method

Select "WPA" or "WPA2" in "Security method", select "OK" and press ENTER.

■ WEP method

Select "WEP" in "Security method", and select "Default Key ID". Then select "OK" and press ENTER.

- If encryption setting has not been made on the wireless LAN router, select "None" in "Security method", select "OK" and press ENTER.

The unit supports the linked system function such as power on/off link when connected via HDMI cable with a CEC (Consumer Electronics Control) compliant TV or player. You need to change the initial setting to use the linked system function, HDMI Through function and ARC (Audio Return Channel) function.

● **Operation:** You can set up by viewing the guidance displayed on the TV screen. To display the guidance, you need to make HDMI connection between the unit and TV. Select the item with the cursor buttons of the remote controller and press ENTER to confirm your selection. To return to the previous screen, press RETURN.

HDMI CEC (RIHD)

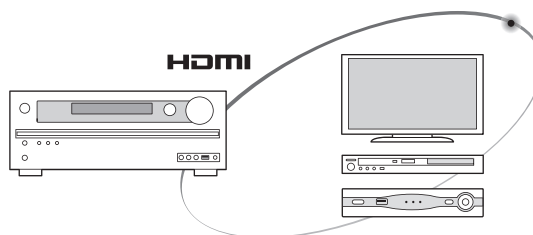

- Turning the TV to standby mode will turn the unit to standby mode.
- On the TV side, it is possible to set whether to output audio from the speakers connected to the unit or from the TV's speakers.
- Starting playback of a CEC compliant player/recorder will automatically switch the unit's input to the HDMI input of the player/recorder. If the unit is in standby mode, it will automatically be turned on.

1. Press RCV on the remote controller and then press HOME.
2. Select "Setup" with the cursor buttons and press ENTER.
3. Select "11. HDMI Setup" with the cursor buttons and press ENTER.
4. Select "HDMI CEC (RIHD)" with the cursor buttons and select "On".

HDMI Through

The function allows transmission from players to the TV even if the unit is in standby. Setting the HDMI CEC (RIHD) setting mentioned above to "On" can enable this setting automatically. It is also necessary to make the HDMI linked system setting on the TV. See the TV's instruction manual for details.

- Although enabling the HDMI Through function increases power consumption during standby, the unit automatically enters the HYBRID STANDBY mode that can minimize the increase of power consumption by keeping only the minimum circuits active.

ARC (Audio Return Channel)

Simple connection to the ARC compatible TV using a single HDMI cable allows to listen to the TV sound from the speakers connected to the unit. To use the ARC function, connect the unit to the ARC compatible HDMI jack of the TV. Then, set the HDMI CEC (RIHD) mentioned above to "On" on the unit, and make the following setting.

1. Press RCV on the remote controller and then press HOME.
2. Select "Setup" with the cursor buttons and press ENTER.
3. Select "11. HDMI Setup" with the cursor buttons and press ENTER.
4. Select "Audio Return Ch" with the cursor buttons and select "Auto".

Audio output of connected players

To enjoy digital surround sound including Dolby Digital and DTS, audio output should be set to "Bitstream output" on the connected blu-ray disc player or other devices. If the TV does not support bitstream signals, set the audio output to "PCM output" on the player to listen to the audio from the TV's speakers. For how to set the player, see the instruction manual of the player. Some settings of the blu-ray disc player may prevent reproduction of DTS-HD Master Audio. In that case, turn "BD video supplementary sound" (or secondary sound) to "Off" and try again.

Step 3: Playing Back

1

Playing the player and TV

Press RCV on the remote controller and press ① **RECEIVER** to turn the power on.

- Switch the input on the TV to that assigned to the unit. Use the TV's remote controller.

1. Select the input of the unit and start playback on the player or TV.

- Press ② **INPUT SELECTOR** to which the desired player has been assigned. Press TV/CD to play the TV's sound. You can also use the input selector buttons on the main unit.
- Input will automatically be selected if the TV or player is CEC compliant and connected to the unit with HDMI cable.

2. Select the desired listening mode.

Press the ⑤ listening mode buttons to switch the mode so that you can enjoy different listening modes. For details about the listening modes, see "Listening modes" on the next page.

3. Adjust the volume with ⑨.

Remote controller parts name

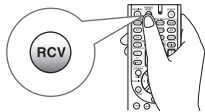

- **To control the unit:** The remote controller may be in the remote mode that enables control of other devices. Press the ② **RCV** button to select the **RECEIVER** mode (for controlling this unit) before starting operation.

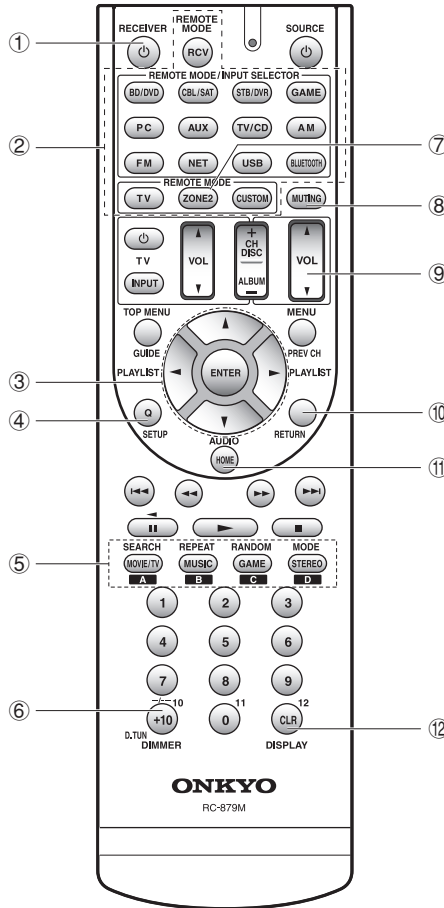

- ① **RECEIVER** button: Turns the unit on or into standby mode.
- ② **REMOTE MODE/INPUT SELECTOR** buttons: Switches the input to be played.
- ③ **Cursor buttons and ENTER** button: Moves the cursor and confirms the selection.
- ④ **Q SETUP** button: Displays the Quick Setup menu that allows you to set the frequently used functions including input selection and volume adjustment.
- ⑤ **Listening mode** buttons: Allows you to select the listening mode.
- ⑥ **DIMMER** button: Switches the brightness of the display.
- ⑦ **ZONE2** button: For use when the unit is connected with a pre-main amplifier in a separate room and sound is played there.
- ⑧ **MUTING** button: Temporarily mutes audio.
- ⑨ **VOLUME** buttons: Allows you to adjust the volume.
- ⑩ **RETURN** button: Returns the display to the previous state.
- ⑪ **HOME** button: Displays the Home menu that allows you to make advanced settings and use Internet radio and DLNA.
- ⑫ **DISPLAY** button: Switches the information on the display.

How to use the remote controller

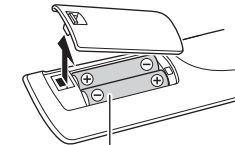

Batteries (AA/R6)

Remote control sensor

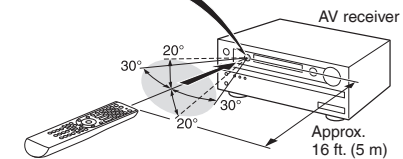

- If you do not use the remote controller for a long time, remove the batteries to prevent leakage.
- Note that keeping consumed batteries inside may cause corrosion resulting in damage of the remote controller.

Listening modes

Select the desired mode by switching and listening actual sound in different modes. The selectable listening modes depend on the format of the input signals.

MOVIE/TV: You can select a listening mode suitable for movies and TV programs.

MUSIC: You can select a listening mode suitable for music.

GAME: You can select a listening mode suitable for games.

STEREO: You can select a listening mode for stereo and all channel stereo sources.

PURE AUDIO (main unit only) (European, Australian and Asian models): The display and analog video circuit is cut off to provide purer sound.

- For details on the listening modes, see the Advanced Manual (<http://www.onkyo.com/manual/txnr535/adv/en.html>).

"Direct" for playing the input signals as-is

Selecting this mode allows the input signals to be played as they are. For example, 2 ch signals of music CD will be played in stereo, 5.1 ch signals in 5.1 ch, and Dolby Digital signals of blu-ray disc or DVD in the Dolby Digital sound field according to the specified number of channels.

■ **Changing the Display Brightness:** Press DIMMER on the remote controller several times to select the desired brightness. (North American and Taiwanese models)

■ **Changing the Input Display:** Press DISPLAY on the remote controller several times to switch the display of the main unit in order of:

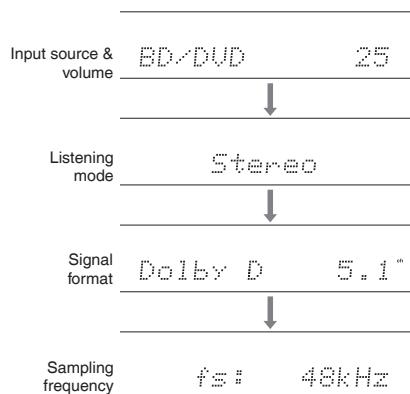

- If "Dolby D 5.1" is displayed in signal format, the Dolby Digital 5.1 ch signals are being input. When listening to AM/FM radio, the band, frequency and preset number are displayed.

2 Listening to AM/FM Radio

Auto tuning method is explained in Basic Manual. For more details on AM/FM radio station, see Advanced Manual (<http://www.onkyo.com/manual/txnr535/adv/en.html>).

- Press **AM** or **FM** on the unit to select either "AM" or "FM".
- Press **TUNING MODE** on the unit so that the "AUTO" indicator on the unit's display lights.

3. Press **▼TUNING▲** on the unit.

The automatic search for a radio station starts. Searching stops when one is found. When tuned into a radio station, the "▶TUNED◀" indicator on the unit's display lights. The "FM STEREO" indicator lights if the radio station is an FM radio station.



Registering a Radio Station: It allows you to register up to 40 of your favorite AM/FM radio stations.

- Tune into the **AM/FM** radio station you want to register.
- Press **MEMORY** on the unit. The preset number on the unit's display flashes.
- Repeatedly press **◀PRESET▶** on the unit to select a number between 1 and 40 while the preset number is flashing (about 8 seconds).
- Press **MEMORY** on the unit again. When registered, the preset number stops flashing. Repeat this procedure for all of your favorite AM/FM radio stations. Press **◀PRESET▶** or **CH +/-** to select the registered radio station.

3 Connecting and playing the Bluetooth-enabled device

You can wirelessly enjoy music files stored in a smartphone or other Bluetooth-enabled device. The coverage area is 48 feet (15 meters).

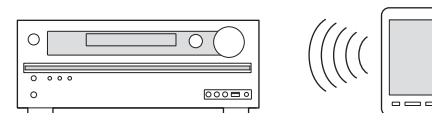

- The Bluetooth-enabled device needs to support the A2DP profile.
- Note that connection is not always guaranteed with all Bluetooth-enabled devices.

Other useful functions

■ **Playing Video and Audio from Different Sources:** It is possible to play audio and video from different sources. For example, you can play audio from the CD player and video from the BD/DVD player. In this case, press BD/DVD and then TV/CD. Then start playback on the BD/DVD player and CD player. This function is effective when an input with audio only has been selected (TV/CD, AM or FM in the initial setting).

■ **Muting Temporarily:** Press MUTING on the remote controller. Press MUTING again to cancel muting.

4 Using the Home menu

In the Home menu, you can make advanced settings and use Internet radio and DLNA.

1. Press RCV on the remote controller and then press HOME.

The Home menu displays on the TV screen. You can also use the HOME button on the main unit.

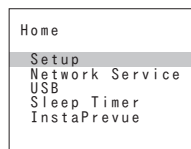

2. Select the item with the cursor buttons of the remote controller and press ENTER to confirm your selection.

- For details on the Setup menu and how to play Internet radio, DLNA and USB storage device, see the Advanced Manual (<http://www.onkyo.com/manual/txnr535/adv/en.html>).
- To return to the previous screen, press RETURN. To return to the Home menu, press HOME.

■ **Setup:** You can change the assignment of input terminals and input selector buttons and also make various speaker settings and other advanced settings.

■ **Network Service:** Select to use various Internet radio services and DLNA.

- "Network Setup" becomes selectable after the network starts up even if it cannot be selected first. It may take about a minute to start up.

■ **USB:** Select to connect a USB storage device to the USB port so that it can be played.

- "USB" becomes selectable after the USB function starts up even if it cannot be selected first. It may take about a minute to start up.

■ **Sleep Timer:** Select to turn the unit into standby mode automatically when the specified time elapses.

Pairing

Pairing is necessary when using the Bluetooth-enabled device for the first time. Before starting the procedure, learn how to enable the Bluetooth setting function and to connect with other devices on the Bluetooth-enabled device.

1. Press BLUETOOTH on the remote controller.

The unit enters the pairing mode and the BLUETOOTH indicator starts flashing.

2. While the BLUETOOTH indicator is flashing, complete connection on the Bluetooth-enabled device in the nearby area within about 2 minutes.

If the name of this unit is displayed on the Bluetooth-enabled device's display, select this unit. Pairing will end after a short time.

- If a password is requested, enter "0000".
- When connecting the unit to any other Bluetooth-enabled device, start pairing by pressing and holding BLUETOOTH until the BLUETOOTH indicator starts flashing. This unit can store the data of up to ten paired devices.

Playing sound of the Bluetooth-enabled device

If the unit is on and the Bluetooth-enabled device is connected, the input will be automatically switched to BLUETOOTH. Play music in this state.

- It may take about a minute until connection is established when the unit is on since the Bluetooth function takes some time to start up.
- If the volume setting on the Bluetooth-enabled device is low, the sound will not be output from this unit.
- Due to the characteristics of Bluetooth wireless technology, the sound produced on this unit may slightly be behind the sound played on the Bluetooth-enabled device.

■ **InstaPrevue:** Select to preview videos input from the HDMI input jacks collectively in a single screen. The screen has a main window (current input video) and sub windows (other input videos). To switch the current input, select the desired sub window with the cursor buttons and press ENTER.

- A black sub window is shown for the input with no video signals.
- "InstaPrevue" cannot be selected if the video is being input from HDMI IN 6 or there is no signal from the input currently selected.
- Depending on video signals, the picture may not be properly rendered on the preview thumbnails.

5 Using Quick Setup menu

In the Quick Setup menu, you can set frequently used functions including input selection and volume adjustment.

1. Press Q SETUP on the remote controller.

The Quick Setup menu is displayed on the connected TV's screen.

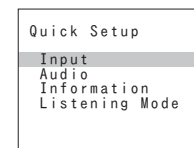

2. Select the item with the cursor buttons of the remote controller and press ENTER to confirm your selection.

- To return to the previous screen, press RETURN.

■ **Input:** Select the input and check the assignment of input selector buttons.

■ **Audio:**

A/V Sync: If the video is behind the audio, you can delay the audio to offset the gap.

- It cannot be set when audio is played from the TV's speakers.
- It cannot be set if the input is "NET", "USB" or "BLUETOOTH".
- It cannot be set if the listening mode is Pure Audio (European, Australian and Asian models) or Direct.

Bass, Treble: Adjust volume of the front speaker.

- It cannot be set if the listening mode is Pure Audio (European, Australian and Asian models) or Direct.

PM Bass (Phase Matching Bass): Suppress phase shift in the midrange to enhance bass sound. Thus smooth and powerful bass sound can be obtained.

- It cannot be set if the listening mode is Pure Audio (European, Australian and Asian models) or Direct.

Subwoofer Level, Center Level: Adjust the speaker level while listening to the sound. The adjustment you made will be reset to the previous status when you turn the unit to standby mode.

- The speakers cannot be adjusted if they have been set to "No" or "None" in "Sp Config".

AccuEQ: Disables the sound field correction settings set in the automatic speaker setting. The setting can be separately set to each input.

- The setting cannot be selected if the automatic speaker setting has not been performed.
- It cannot be set if headphones are connected or the listening mode is Pure Audio (European, Australian and Asian models) or Direct.

Late Night: Make small sounds to be easily heard. It is useful when you need to reduce the volume while watching a movie late night. You can enjoy the effect on Dolby Digital, Dolby Digital Plus and Dolby TrueHD sources only.

- Turning the unit to standby mode will set the setting to "Off". In case of Dolby TrueHD, the setting will be set to "Auto".

Music Optimizer : Improve the quality of the compressed audio. Playback sound of lossy compressed files such as MP3 will be improved. The setting can be separately set to each input.

- The setting is effective in the signals of 48 kHz or less. The setting is not effective in the bitstream signals.
- It cannot be set if the listening mode is Pure Audio (European, Australian and Asian models) or Direct.

Cinema Filter: Adjust the soundtrack that was processed to enhance its high pitch range, in order to make it suitable for home theater.

- This function can be used in the following listening modes: Multichannel, Dolby Digital, Dolby Digital Plus, Dolby TrueHD, DTS, DTS-HD High Resolution Audio, DTS-HD Master Audio, DTS Express, DTS 96/24, Dolby PL II Movie, and Neo:6 Cinema.

■ **Information:** Display the audio information.

■ **Listening Mode:** Select the listening mode from the categories of "MOVIE/TV", "MUSIC" and "GAME".

- It cannot be set when audio is played from the TV's speakers.

6 Using the ZONE function

You can connect the unit with a pre-main amplifier in a separate room and play the sound from the device connected to the unit via analog connection or from the "NET", "USB" or "BLUETOOTH" source. It is also possible to play the sound from different analog connected devices in the main room and separate room.

- As for the "NET", "USB" and "BLUETOOTH", you cannot select different inputs for the main room and separate room. For example, if "NET" has been selected in the main room and then "USB" is selected on the pre-main amplifier in the separate room, the input in the main room will change to "USB" accordingly.
- When listening to AM/FM broadcasting, you cannot select different stations for the main room and separate room. Therefore broadcasting of the same station will be heard in the both rooms.

Making ZONE connection

Connect the ZONE 2 LINE OUT jacks of the unit and the line-in jacks of the pre-main amplifier in a separate room with an analog audio (RCA) cable.

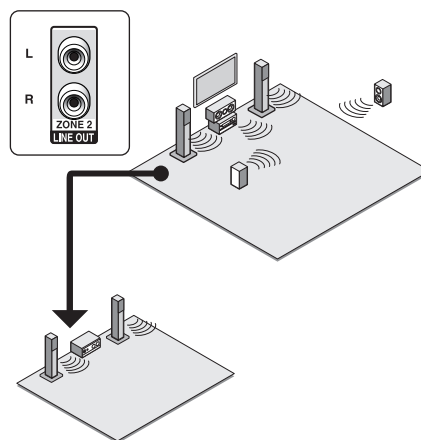

Performing ZONE playback

1. **Press ZONE2 on the remote controller, point the remote controller at the remote controller sensor and press ◀RECEIVER.**
"Z2" lights on the unit and the ZONE function is enabled. (ZONE 2 is now on.)
2. **Press ZONE2 on the remote controller again and press INPUT SELECTOR of the input to be played in a separate room.**
To play the same source in the main room and separate room, hold down ZONE2 for approximately 3 seconds. The volume should be adjusted with the pre-main amplifier used in the separate room.
* To control ZONE playback on the main unit, press ZONE2 and within 8 seconds, press the input selector button of the input to be played in a separate room. To play the same source in the main room and separate room, press ZONE2 twice. "Z2 : Source" appears on the unit's display.

To turn off the ZONE function: Press ZONE2 on the remote controller and press ◀RECEIVER. Alternatively press OFF on the main unit.

- If ZONE 2 is on, power consumption during standby becomes larger than normal.
- If ZONE 2 is turned on when the listening mode of the main room is Pure Audio, it will automatically switch to Direct. (European, Australian and Asian models)
- While ZONE 2 is on, the RI linked system function (interlink between Onkyo components) is disabled.

Parts Name

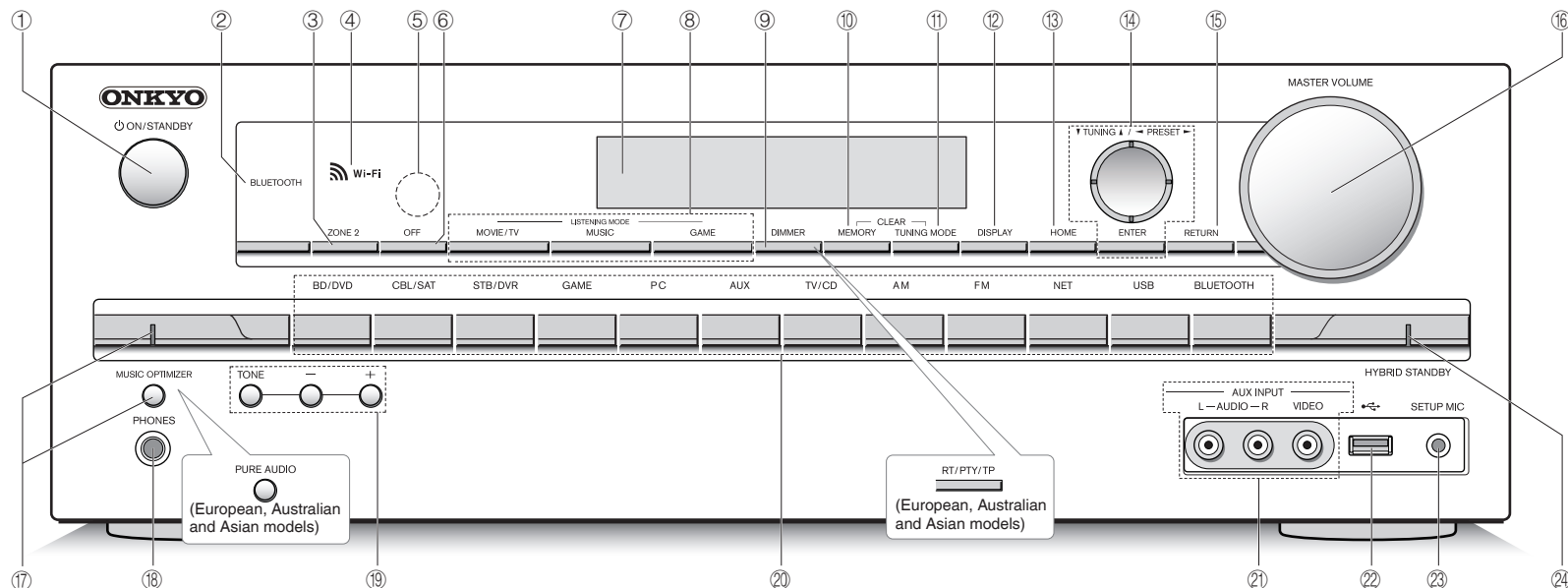

Front Panel

- ① **ON/STANDBY button:** Turns the unit on or into standby mode.
- ② **BLUETOOTH indicator:** Flashes while pairing with a Bluetooth-enabled device is in progress and stays lit when pairing is completed.
- ③ **ZONE 2 button:** Controls the ZONE function.
- ④ **Wi-Fi indicator:** Lights when the unit is connected to the wireless LAN router.
- ⑤ **Remote control sensor:** Receives signals from the remote controller.
- ⑥ **OFF button:** Switches the ZONE function to off.
- ⑦ **Display**
- ⑧ **Listening mode buttons:** Allows you to select the listening mode.
- ⑨ **DIMMER button (North American and Taiwanese models):** Switches the brightness of the display.
RT/PTY/TP button (European, Australian and Asian models): Can be used when receiving the station transmitting text information.
- ⑩ **MEMORY button:** Registers or deletes a station.
- ⑪ **TUNING MODE button:** Switches the tuning mode.
- ⑫ **DISPLAY button:** Switches the information on the display.
- ⑬ **HOME button:** Displays the Home menu.
- ⑭ **Cursor buttons, TUNING button, PRESET button and ENTER button:** Moves the cursor and confirms the selection. When listening to AM/FM broadcasting, tune in to the station with TUNING or select the registered station with PRESET.
- ⑮ **RETURN button:** Returns the display to the previous state.
- ⑯ **MASTER VOLUME:** Allows you to adjust the volume.
- ⑰ **MUSIC OPTIMIZER button and indicator (North American and Taiwanese models):** Turns on/off the MUSIC OPTIMIZER function that improves the quality of the compressed audio.
PURE AUDIO button and indicator (European, Australian and Asian models): Switches to the PURE AUDIO mode.
- ⑱ **PHONES and Tone Level buttons:** Adjusts the high tone and low tone.
- ⑲ **TONE and Tone Level buttons:** Adjusts the high tone and low tone.
- ⑳ **Input selector buttons:** Switches the input to be played.
- ㉑ **AUX INPUT AUDIO/VIDEO jacks:** A video camera or such other device is connected.
- ㉒ **USB port:** A USB storage device is connected so that music files stored in it can be played.
- ㉓ **SETUP MIC jack:** The supplied speaker setup microphone is connected.
- ㉔ **HYBRID STANDBY indicator:** Lights if the unit enters standby mode when the HDMI Through, network standby or Wakeup from Bluetooth function is enabled.

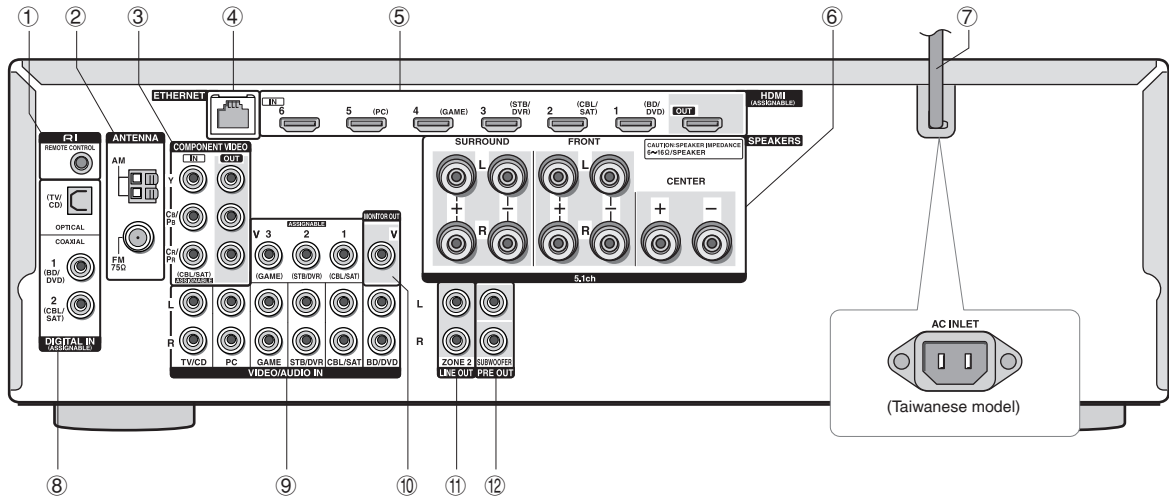

Rear Panel

- ① **RI REMOTE CONTROL jack:** An Onkyo product with RI jack can be connected and synchronized with this unit.
- ② **FM ANTENNA jack (75 Ω) and AM ANTENNA terminal:** The supplied antennas are connected.
- ③ **COMPONENT VIDEO IN and OUT jacks:** Component video input/output jacks
- ④ **ETHERNET port:** Used for LAN connection
- ⑤ **HDMI IN/OUT jacks:** Digital video signals and audio signals are transmitted between the unit and the connected devices.
- ⑥ **SPEAKERS terminals:** Speakers are connected.
- ⑦ **Power cord (North American, European, Australian and Asian models)**
AC INLET (Taiwanese model): The power cord is connected.
- ⑧ **DIGITAL IN COAXIAL/OPTICAL jacks:** Digital audio signals are input.
- ⑨ **Composite video and analog audio jacks:** Analog video signals and audio signals are input.
- ⑩ **MONITOR OUT V jack:** Video signals are output to the connected monitor or TV.

- ⑪ **ZONE 2 LINE OUT jacks:** Analog audio signals are output to the connected amplifier to be used in ZONE 2.
- ⑫ **SUBWOOFER PRE OUT jacks:** A subwoofer with built-in amplifier is connected.

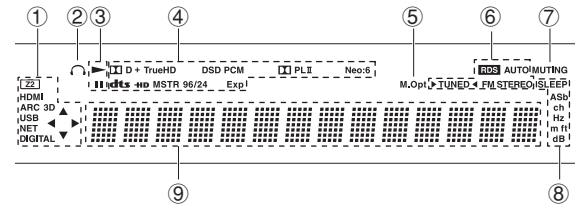

Display

- ① Lights in the following conditions. "Z2": ZONE 2 output is on. / "HDMI": HDMI signals are input and HDMI input selector is selected. / "ARC": Audio signals are input from ARC compatible TV and TV/CD input selector is selected. / "3D": Input signals are 3D. / "USB" (*): "USB" input is selected and USB storage device is connected. / "NET" (*): "NET" input is selected and the unit is connected to the network. / "DIGITAL": Digital signals are input and the digital input selector is selected. / Cursor indicators: NET or USB is controlled. * "USB" and "NET" will flash if the connection is not correct.
- ② Lights when headphones are connected.
- ③ Lights when NET or USB is controlled.
- ④ Lights according to the type of input digital signals and the listening mode.
- ⑤ Lights when Music Optimizer is enabled.
- ⑥ Lights in the following conditions. "AUTO": Tuning mode is auto. / "▶TUNED◀": Receiving AM/FM radio. ▶◀ flashes while tuning is automatically performed. / "FM STEREO": Receiving FM stereo. / "RDS" (European, Australian and Asian models): Receiving RDS broadcasting.
- ⑦ "MUTING": Flashes when muting is on.
- ⑧ Lights in the following conditions. "SLEEP": Sleep timer has been set. / "ASb" (Auto Standby): Auto Standby is on. / "ch": Channel is being set. / "Hz": Crossover frequencies are being set. / "m/ft": Speaker distances are being set. / "dB": Speaker volume is being set.
- ⑨ Displays various information of the input signals. Pressing DISPLAY displays the type of input digital signals and the listening mode.

Troubleshooting

The AV receiver turns off unexpectedly.

- The AV receiver will automatically enter standby mode when Auto Standby is set and launched.

There's no sound, or it's very quiet.

- A wrong input selector button has been selected. Select a correct input for the player. Also check that muting is not on.
- Not all listening modes use all speakers.

There's no picture.

- A wrong input selector button has been selected.
- There will be no video output, if the listening mode is Pure Audio. (European, Australian and Asian models)
- To display video from the connected player on the TV screen while the unit is in standby, you need to enable "HDMI Through".
- When the TV image is blurry or unclear, power code or connection cables of the unit may have interfered. In that case, keep distance between TV antenna cable and cables of the unit.

HDMI control does not function correctly.

- Set the HDMI CEC (RIHD) setting of the unit to "On". It is also necessary to make the HDMI linked system setting on the TV. See the TV's instruction manual for details.

The remote controller does not work.

- Be sure to press RCV first before operating the unit with the remote controller.

Cannot access to network.

- Try plugging/unplugging the unit or the wireless LAN router or check their power-on status. This will work well in many cases.
- If the desired wireless LAN router is not in the access point list, it may be set to hide SSID or the ANY connection may be off. Change the setting and try again.
- Place the AV receiver away from the devices emitting electromagnetic waves on the 2.4 GHz band (microwave

ovens, game consoles, etc.). If this does not solve the problem, stop using other devices which emit electromagnetic waves.

- When other wireless LAN devices are used near the AV receiver, several issues such as interrupted playback and communication may occur. You can avoid these issues by changing the channel of your Wi-Fi router. For instructions on changing channels, see the instruction manual provided with your Wi-Fi router.
- If there is a metallic object near the AV receiver, wireless LAN connection may not be possible as the metal can effect on the radio wave.
- If there is more than one access point in the network, separate each access point.

Bluetooth

- Try plugging/unplugging the unit and the Bluetooth-enabled player. After that, check that the Bluetooth function is enabled on the Bluetooth-enabled device and the connection with the unit has been established.

■ Before requesting a service

If the methods listed above cannot solve your problem, try plugging/unplugging the power cord and connection cables of the unit and/or reset the unit status. If you reset the unit status, your preferences will be reset to the defaults. Note them down before starting reset.

- **How to reset:** Perform steps 1 and 2 below. "Clear" will appear on the display and the unit returns to standby.

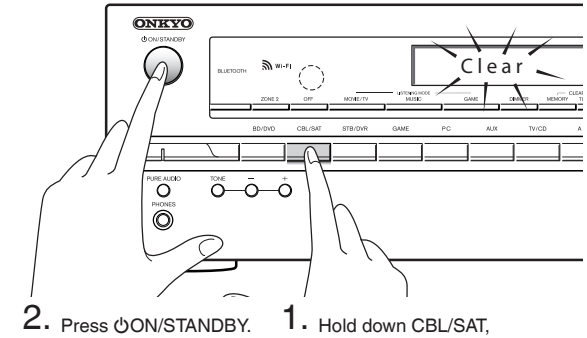

- **How to initialize the remote controller:** To initialize the remote controller to its factory defaults, while holding down RCV, press and hold HOME until the remote indicator lights (about 3 seconds). Within 30 seconds, press RCV again.

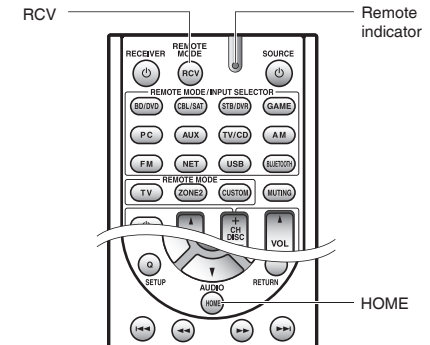

Specifications

Amplifier Section

Rated Output Power

All channels:

65 watts minimum continuous power per channel, 8 ohm loads, 2 channels driven from 20 Hz to 20 kHz, with a maximum total harmonic distortion of 0.7% (FTC)

90 watts minimum continuous power per channel, 6 ohm loads, 2 channels driven at 1 kHz, with a maximum total harmonic distortion of 0.7% (FTC)

(North American)

5 ch x 100 W at 6 ohms, 1 kHz,

1 ch driven of 1% (IEC) (Others)

Maximum Effective Output Power

5 ch x 120 W at 6 ohms, 1 kHz,

1 ch driven (JEITA)

(Asian)

Dynamic Power (*)

* IEC60268-Short-term maximum output power

160 W (3 Ω, Front)

125 W (4 Ω, Front)

85 W (8 Ω, Front)

THD+N (Total Harmonic Distortion+Noise)

0.7% (20 Hz - 20 kHz, half power)

Damping Factor

60 (Front, 1 kHz, 8 Ω)

Input Sensitivity and Impedance (Unbalance)

200 mV/47 kΩ (LINE)

Rated RCA Output Level and Impedance

200 mV/2.2 kΩ (LINE OUT)

Maximum RCA Output Level and Impedance

2 V/2.2 kΩ (LINE OUT)

Frequency Response

5 Hz - 100 kHz/+1 dB, -3 dB (Direct mode)

Tone Control Characteristics

±10 dB, 20 Hz (BASS)

±10 dB, 20 kHz (TREBLE)

Signal to Noise Ratio

100 dB (LINE, IHF-A)

Speaker Impedance

6 Ω - 16 Ω

Video Section

Input Sensitivity/Output Level and Impedance

1 V_{p-p}/75 Ω (Component Y)

0.7 V_{p-p}/75 Ω (Component P_B/C_B, P_R/C_R)

1 V_{p-p}/75 Ω (Composite)

Component Video Frequency Response

5 Hz - 100 MHz/+0 dB, -3 dB

Tuner Section

FM Tuning Frequency Range

87.5 MHz - 107.9 MHz

(North American and Taiwanese)

87.5 MHz - 108.0 MHz, RDS (Others)

AM Tuning Frequency Range

522/530 kHz - 1611/1710 kHz

Preset Channel

40

Network Section

Ethernet LAN

10BASE-T/100BASE-TX

Wireless LAN

IEEE 802.11 b/g/n standard

(Wi-Fi® standard)

2.4 GHz band:

1 - 11 ch (North American)

10 - 11 ch (Spain)

10 - 13 ch (France)

1 - 13 ch (Others)

(Wi-Fi® standard)

Bluetooth Section

Communication system

Bluetooth Specification version 2.1 +EDR (Enhanced Data Rate)

Maximum communication range

Line of sight approx. 15 m (*)

Frequency band

2.4 GHz band (2.4000 GHz - 2.4835 GHz)

Modulation method

FHSS (Freq Hopping Spread Spectrum)

Compatible Bluetooth profiles

A2DP 1.2 (Advanced Audio Distribution Profile)

AVRCP 1.3 (Audio Video Remote Control Profile)

Supported Codercs

SBC

Transmission range (A2DP)

20 Hz - 20,000 Hz (Sampling frequency 44.1 kHz)

* The actual range will vary depending on factors such as obstacles between devices, magnetic fields around a microwave oven, static electricity, cordless phone, reception sensitivity, antenna's performance, operating system, software application, etc.

General

Power Supply

AC 120 V, 60 Hz (North American and Taiwanese)

AC 230 V, 50 Hz (European, Australian and British)

AC 220 - 240 V, 50/60 Hz (Others)

Power Consumption

3.2 A (North American and Taiwanese)

330 W (European, Australian and British)

380 W (Others)

0.1 W (Stand-by, North American and Taiwanese)

0.2 W (Stand-by, Others)

55 W (No-sound)

Dimensions (W x H x D)

435 mm x 150 mm x 329 mm

17-1/8" x 5-7/8" x 12-15/16"

Weight

7.6 kg (16.8 lbs.) (North American and Taiwanese)

8.1 kg (17.9 lbs.) (Others)

■ HDMI

Input

IN1 (BD/DVD), IN2 (CBL/SAT), IN3 (STB/DVR), IN4 (GAME), IN5 (PC), IN6

Output

OUT

Video Resolution

4K 60 Hz (YCbCr 4:2:0)

Audio Format

DTS-HD Master Audio, DTS-HD High Resolution Audio, Dolby TrueHD, Dolby Digital Plus, DSD, Multichannel PCM

Supported

3D, Audio Return Channel, DeepColor, x.v.Color, LipSync, CEC (RIHD), 4K Passthrough

■ Video Inputs

Component

IN (CBL/SAT)

Composite

IN1 (CBL/SAT), IN2 (STB/DVR), IN3 (GAME), AUX

■ Video Outputs

Component

OUT

Composite

MONITOR OUT

■ Audio Inputs

Digital

OPTICAL (TV/CD)

COAXIAL 1 (BD/DVD), 2 (CBL/SAT)

Analog

BD/DVD, CBL/SAT, STB/DVR, GAME, PC, TV/CD, AUX

■ Audio Outputs

Analog

ZONE2 LINE OUT

2 SUBWOOFER PRE OUT

Speaker Outputs

FRONT L/R, CENTER, SURROUND L/R

Phones

PHONES (Front, ø 6.3)

■ Others

Setup Mic 1 (Front)

RI 1

USB 1 (Front)

Ethernet 1

Specifications and features are subject to change without notice.

License and Trademark Information



Manufactured under license from Dolby Laboratories. Dolby, Pro Logic and the double-D symbol are trademarks of Dolby Laboratories.



For DTS patents, see <http://patents.dts.com>. Manufactured under license from DTS Licensing Limited. DTS, DTS-HD, the Symbol, & DTS and the Symbol together are registered trademarks of DTS, Inc. © DTS, Inc. All Rights Reserved.



"CINEMA FILTER" and "CINEMA FILTER (logo)" are trademarks of Onkyo Corporation.

AccuEQ, Music Optimizer, RIHD and WRAT are trademarks of Onkyo Corporation.

"RIHD" and "RIHD (logo)" are trademarks of Onkyo Corporation.



The terms HDMI and HDMI High-Definition Multimedia Interface, and the HDMI Logo are trademarks or registered trademarks of HDMI Licensing LLC in the United States and other countries.



The Wi-Fi CERTIFIED® Logo is a certification mark of the Wi-Fi Alliance. Wi-Fi certified® logo shows international association certifying interoperability "Wi-Fi alliance" ensures the product has passed the test for compatibility with other Wi-Fi certified equipment.



The Bluetooth® word mark and logos are registered trademarks owned by Bluetooth SIG, Inc. and any use of such marks by Onkyo is under license. Other trademarks and trade names are those of their respective owners.

Onkyo does not guarantee Bluetooth compatibility between the AV receiver and all Bluetooth-enabled devices.

For compatibility between the AV receiver and another device with Bluetooth technology, consult the device's documentation and dealer. In some countries, there may be restrictions on using Bluetooth devices. Check with your local authorities.

InstaPrevue and the InstaPrevue logo are trademarks or registered trademarks of Silicon Image, Inc. in the United States and other countries.

Apple, iPod and iPhone are trademarks of Apple Inc., registered in the U.S. and other countries.

Apple TV is a trademark of Apple Inc., registered in the U.S. and other countries.



SIRIUS, XM and all related marks and logos are trademarks of Sirius XM Radio Inc. and its subsidiaries. All rights reserved.

DLNA®, the DLNA Logo and DLNA CERTIFIED® are trademarks, service marks, or certification marks of the Digital Living Network Alliance.

This product is protected by certain intellectual property rights of Microsoft. Use or distribution of such technology outside of this product is prohibited without a license from Microsoft.

Windows and the Windows logo are trademarks of the Microsoft group of companies.

QR Code is a registered trademark of DENSO WAVE INCORPORATED.

Safari is a trademark or registered trademark of Apple Computer, Inc. in the US and other countries.

"x.v.Color" is a trademark of Sony Corporation.

MPEG Layer-3 audio coding technology licensed from Fraunhofer IIS and Thomson.

"All other trademarks are the property of their respective owners."

Precautions

For European Models

Declaration of Conformity

We declare, under our sole responsibility, that this product complies with the standards:

- Safety
- Limits and methods of measurement of radio disturbance characteristics
- Limits for harmonic current emissions
- Limitation of voltage changes, voltage fluctuations and flicker
- RoHS Directive, 2011/65/EU
- Hereby, Onkyo Corporation, declares that this TX-NR535 is in compliance with the essential requirements and other relevant provisions of Directive 1999/5/EC.
- С настоящето, Onkyo Corporation, декларира, че TX-NR535 е в съответствие със съществените изисквания и другите приложими разпоредби на Директива 1999/5/EC.
- Onkyo Corporation tímto prohlašuje, že TX-NR535 splňuje základní požadavky a všechna příslušná ustanovení Směrnice 1999/5/ES.
- Undertegnede Onkyo Corporation erklærer herved, at følgende udstyr TX-NR535 overholder de væsentlige krav og øvrige relevante krav i direktiv 1999/5/EF.
- Hiermit erklärt Onkyo Corporation, dass sich das Gerät TX-NR535 in Übereinstimmung mit den grundlegenden Anforderungen und den übrigen einschlägigen Bestimmungen der Richtlinie 1999/5/EG befindet.
- Käesolevaga kinnitab Onkyo Corporation seadme TX-NR535 vastavust direktiivi 1999/5/EÜ põhinõuetele ja nimetatud direktiivist tulenevatele teistele asjakohastele sätetele.
- ΜΕ ΤΗΝ ΠΑΡΟΥΣΑ Ο ΚΑΤΑΣΚΕΥΑΣΤΗΣ Onkyo Corporation ΔΗΛΩΝΕΙ ΟΤΙ ΤΑ TX-NR535 ΣΥΜΜΟΡΦΩΝΕΤΑΙ ΠΡΟΣ ΤΙΣ ΟΥΣΙΩΔΕΙΣ ΑΠΑΙΤΗΣΕΙΣ ΚΑΙ ΤΙΣ ΛΟΙΠΕΣ ΣΧΕΤΙΚΕΣ ΔΙΑΤΑΞΕΙΣ ΤΗΣ ΟΔΗΓΙΑΣ 1999/5/ΕΚ
- Por la presente, Onkyo Corporation, declara que este TX-NR535 cumple con los requisitos esenciales y otras exigencias relevantes de la Directiva 1999/5/EC.
- Par la présente, Onkyo Corporation déclare que l'appareil TX-NR535 est conforme aux exigences essentielles et aux autres dispositions pertinentes de la directive 1999/5/CE.
- Con la presente Onkyo Corporation dichiara che questo TX-NR535 è conforme ai requisiti essenziali ed alle altre disposizioni pertinenti stabilite dalla direttiva 1999/5/CE.
- Ar šo Onkyo Corporation deklarē, ka TX-NR535 atbilst Direktīvas 1999/5/EK būtiskajām prasībām un citiem ar to saistītajiem noteikumiem.
- Šiuo Onkyo Corporation deklaruoja, kad šis TX-NR535 atitinka esminius reikalavimus ir kitas 1999/5/EB Direktyvos nuostatas.
- A Onkyo Corporation ezzennel kijelenti, hogy a TX-NR535 típusú berendezés teljesíti az alapvető követelményeket és más 1999/5/EK irányelvben meghatározott vonatkozó rendelkezéseket.
- Hierbij verklaart Onkyo Corporation dat het toestel I TX-NR535 in overeenstemming is met de essentiële eisen en de andere relevante bepalingen van richtlijn 1999/5/EG.



- Niniejszym Onkyo Corporation deklaruje że TX-NR535 jest zgodny z zasadniczymi wymaganiami i innymi właściwymi postanowieniami Dyrektywy 1999/5/EC.
- Eu, Onkyo Corporation, declaro que o TX-NR535 cumpre os requisitos essenciais e outras provisões relevantes da Directiva 1999/5/EC.
- Prin prezenta, Onkyo Corporation, declară că aparatul TX-NR535 este în conformitate cu cerințele esențiale și cu alte prevederi pertinente ale Directivei 1999/5/CE.
- Onkyo Corporation týmto vyhlasuje, že TX-NR535 a splnía základné požiadavky a všetky príslušné ustanovenia Smernice 1999/5/ES.
- Onkyo Corporation izjavlja, da je ta TX-NR535 v skladu z bistvenimi zahtevami in drugimi relevantnimi določili direktive 1999/5/ES.
- Onkyo Corporation vakuuttaa täten että TX-NR535 tyypinen laite on direktiivin 1999/5/EY oleellisten vaatimusten ja sitä koskevien direktiivin muiden ehtojen mukainen.
- Härmed förklarar Onkyo Corporation att denna TX-NR535 följer de väsentliga kraven och andra relevanta stadgar i Direktiv 1999/5/EC.
- Hér með lýsir Onkyo Corporation því yfir að varan TX-NR535 er í samræmi við grunnkröfur og aðrar kröfur sem gerðar eru í tilskipun 1999/5/EC.
- Onkyo Corporation erklærer herved at denne TX-NR535 er i overensstemmelse med vesentlige krav og andre relevante bestemmelser i direktiv 1999/5/EC.
- Ovime Onkyo Corporation, potvrđuje da je TX-NR535 u suglasnosti sa osnovnim zahtjevima i ostalim relevantnim odredbama Direktive 1999/5/EC.

ONKYO

Onkyo Corporation

Kitahama Chuo Bldg, 2-2-22 Kitahama, Chuo-ku, OSAKA 541-0041, JAPAN

<http://www.onkyo.com/>

The Americas

Onkyo U.S.A. Corporation

18 Park Way, Upper Saddle River, N.J. 07458, U.S.A.

For Dealer, Service, Order and all other Business Inquiries:

Tel: 201-785-2600 Fax: 201-785-2650

<http://www.us.onkyo.com/>

For Product Support Team Only:

1-800-229-1687

Europe

Onkyo Europe Electronics GmbH

Liegnitzerstrasse 6, 82194 Groebenzell, GERMANY

Tel: +49-8142-4401-0 Fax: +49-8142-4208-213

<http://www.eu.onkyo.com/>

Onkyo Europe Electronics GmbH (UK Branch)

Meridien House, Ground floor, 69 - 71 Clarendon Road, Watford, Hertfordshire, WD17 1DS, United Kingdom

Tel: +44 (0)8712-00-19-96 Fax: +44 (0)8712-00-19-95

China

Onkyo China Limited (Hong Kong)

Unit 1033, 10/F, Star House, No 3, Salisbury Road, Tsim Sha Tsui Kowloon, Hong Kong.

Tel: 852-2429-3118 Fax: 852-2428-9039

<http://www.hk.onkyo.com/>

Onkyo China PRC (Mainland)

1301, 555 Tower, No.555 West NanJing Road, Jing'an District, Shanghai, China 200041,

Tel: 86-21-52131366 Fax: 86-21-52130396

<http://www.cn.onkyo.com/>

Asia, Oceania, Middle East, Africa

Please contact an Onkyo distributor referring to Onkyo SUPPORT site.

<http://www.intl.onkyo.com/support/>

The above-mentioned information is subject to change without prior notice.

Visit the Onkyo web site for the latest update.

SN 29401733

(C) Copyright 2014 Onkyo Corporation Japan. All rights reserved.

D1402-0



* 2 9 4 0 1 7 3 3 *

■ Support for Spotify Connect

Spotify Connect can be supported by updating the unit's firmware. Simply click the Connect icon and select the unit on the playback screen of Spotify application to enjoy high quality music streaming. To enable Spotify Connect, install the Spotify application on your smartphone or tablet first. Then, create a Spotify premium account.

* The Spotify software is subject to third party licenses found here:
www.spotify.com/connect/third-party-licenses

Notes for using multi-zone function

- To enjoy Spotify music in a separate room, select "NET" as the input of the separate room.
- Volume adjustment with the Spotify application is possible only for the equipment connected to the ZONE2/3 speaker terminals (compatible model only). If any other terminal is used for connection, adjust the volume on the audio equipment placed in a separate room.
- To enjoy Spotify music in the main room after playing Spotify in a separate room, select "NET" as the input of the main room.

Auto Power On

- Turning network standby on allows you to use the Auto Power On function when using the Spotify application.

■ Support pour Spotify Connect

Spotify Connect peut être pris en charge par la mise à jour du logiciel de l'unité. Cliquez simplement sur l'icône Connect et sélectionnez l'unité sur l'écran de lecture de l'application Spotify pour profiter de la diffusion audio de haute qualité. Pour activer Spotify Connect, installez l'application Spotify sur votre smartphone ou tablette en premier. Puis, créez un compte premium Spotify.

* Le logiciel Spotify est soumis à des licences de tiers que vous trouverez ici :
www.spotify.com/connect/third-party-licenses

Remarques concernant la fonction multizone

- Pour profiter de la musique Spotify dans une pièce séparée, sélectionnez « NET » comme entrée de la pièce séparée.
- Le réglage du volume avec l'application Spotify n'est possible que pour l'équipement connecté aux bornes d'enceintes ZONE2/3 (modèle compatible seulement).

Si un autre type de borne est utilisé pour la connexion, réglez le volume sur l'équipement audio placé dans une pièce séparée.

- Afin de profiter de la musique Spotify dans la pièce principale après la lecture de Spotify dans une pièce séparée, sélectionnez « NET » comme entrée de la pièce principale.

Mise sous tension automatique

- La mise en veille du réseau vous permet d'utiliser la fonction de mise sous tension automatique lors de l'utilisation de l'application Spotify.

■ Compatibilidad con Spotify Connect

Spotify Connect será compatible mediante la actualización del firmware de la unidad. Simplemente haga clic en el icono Connect y seleccione la unidad en la pantalla de reproducción de la aplicación Spotify para disfrutar de transmisión de música de alta calidad. Para habilitar Spotify Connect, instale primeramente la aplicación Spotify en su teléfono inteligente o tableta. A continuación, cree una cuenta Spotify premium.

* El software de Spotify está protegido por licencias de terceros que encontrará en:
www.spotify.com/connect/third-party-licenses

Notas sobre el uso de función multizona

- Para disfrutar de la música de Spotify en otra habitación, seleccione "NET" como la entrada de dicha habitación.
- Con la aplicación Spotify podrá ajustar el volumen solamente del equipo conectado a los terminales del altavoz ZONE2/3 (únicamente modelos compatibles). Si usa cualquier otro terminal para la conexión, ajuste el volumen en el equipo de audio ubicado en dicha habitación independiente.
- Para disfrutar de la música de Spotify en la habitación principal después de reproducirla en otra habitación Spotify, seleccione "NET" como la entrada de la habitación principal.

Activación automática

- Activar el modo de espera de red le permite usar la función de activación automática al utilizar la aplicación Spotify.

■ Supporto per Spotify Connect

Spotify Connect può essere supportato tramite l'aggiornamento del firmware dell'unità. È sufficiente cliccare sull'icona Connect e selezionare l'unità sulla schermata di riproduzione dell'applicazione Spotify per fruire di streaming di musica ad alta qualità. Per abilitare Spotify Connect, installare anzitutto l'applicazione Spotify sul proprio smartphone o tablet. Quindi, creare un account premium Spotify.

* Il software Spotify è soggetto a licenze di terze parti presenti all'indirizzo:
www.spotify.com/connect/third-party-licenses

Note per l'utilizzo della funzione multi-zona

- Per fruire di musica Spotify in una stanza separata, selezionare "NET" come ingresso della stanza separata.
- La regolazione del volume con l'applicazione Spotify è possibile solo per l'apparecchiatura collegata ai terminali dell'altoparlante ZONE2/3 (solo modello compatibile). Se viene utilizzato qualsiasi altro terminale per il collegamento, regolare il volume sull'apparecchiatura audio posizionata in una stanza separata.
- Per fruire di musica Spotify nella stanza principale dopo aver riprodotto Spotify in una stanza separata, selezionare "NET" come ingresso della stanza principale.

Accensione automatica

- L'attivazione dello standby di rete consente di utilizzare la funzione di accensione automatica quando si utilizza l'applicazione Spotify.

D1410-0

SN 29402014

(C) Copyright 2014 Onkyo Corporation Japan. All rights reserved.

■ Unterstützung für Spotify Connect

Spotify Connect kann durch Aktualisierung der Firmware des Geräts unterstützt werden. Klicken Sie einfach auf das Symbol Connect und wählen Sie das Gerät auf dem Wiedergabe-Bildschirm der Anwendung Spotify, um hochwertiges Musik-Streaming zu genießen. Zur Aktivierung von Spotify Connect, installieren Sie die Anwendung Spotify zuerst auf Ihrem Smartphone oder Tablet. Erstellen Sie dann einen Spotify Premium-Account.

* Die Software Spotify benötigt Lizenzen dritter Parteien, die Sie hier finden:
www.spotify.com/connect/third-party-licenses

Hinweise zur Verwendung der Multizonenfunktion

- Zum Genuss von Spotify Musik in einem anderen Raum, wählen Sie „NET“ als Eingang für den anderen Raum aus.
- Lautstärken-Einstellung mit der Anwendung Spotify ist nur für Ausrüstung möglich, die mit den Lautsprecheranschlüssen ZONE2/3 verbunden ist (nur kompatibles Modell). Wird für die Verbindung ein anderer Anschluss verwendet, passen Sie die Lautstärke an der Audio-Ausrüstung an, die in einem anderen Raum platziert ist.
- Zum Genuss von Spotify Musik im Hauptraum nach dem Abspielen von Spotify in einem anderen Raum, wählen Sie „NET“ als Eingang für den Hauptraum aus.

Auto Power Ein

- Einschalten von Netzwerk-Standby ermöglicht Ihnen die Verwendung der Auto Power Ein-Funktion, wenn Sie die Anwendung Spotify verwenden.

■ Ondersteuning voor Spotify Connect

Spotify Connect kan worden ondersteund door de firmware van het toestel bij te werken. Klik simpelweg op het pictogram Connect en selecteer het toestel op het weergavescherm van de Spotify-toepassing om te genieten van hoogwaardige muziekstreaming. Om Spotify Connect in te schakelen, installeert u eerst de Spotify-toepassing op uw smartphone of tablet. Maak vervolgens een premium account voor Spotify.

* De software van Spotify is onderworpen aan licenties van derde partijen die u hier terugvindt:
www.spotify.com/connect/third-party-licenses

Opmerkingen voor gebruik van de multi-zonefunctie

- Om te genieten van muziek van Spotify in een aparte ruimte, selecteert u „NET“ als de invoer van de aparte ruimte.
- Volumeregeling met de Spotify-toepassing is alleen mogelijk voor de apparatuur verbonden met de ZONE2/3-luidspreker aansluitingen (alleen compatibel model). Als een andere aansluiting wordt gebruikt voor de verbinding, regel het volume dan op de audioapparatuur in een aparte ruimte.
- Om te genieten van muziek van Spotify in de hoofdruimte na het afspelen van Spotify in een aparte ruimte, selecteert u „NET“ als de invoer van de hoofdruimte.

Automatisch Inschakelen Aan

- Als u het netwerk in stand-by zet, kunt u de functie Automatisch Inschakelen Aan gebruiken wanneer u de Spotify-toepassing gebruikt.

■ Stöd för Spotify Connect

Spotify Connect stöds genom att uppdatera enhetens firmware. Klicka på Connect-ikonen och välj enheten på Spotify-applikationens uppspelningsskärm för att njuta av högkvalitativ musik-streaming. För att aktivera Spotify Connect, måste du först installera Spotify-applikationen på din smartphone eller surfplatta. Skapa sedan ett Spotify-premiumkonto.

* Spotify-programvaran omfattas av tredjepartslicenser som kan hittas här:
www.spotify.com/connect/third-party-licenses

Anmärkningar för användning av multizonfunktionen

- För att uppleva Spotify-musik i ett annat rum, välj ”NET” som inmatning för det andra rummet.
- Justering av volymen för Spotify-applikationen är endast möjlig för utrustningen som är ansluten till ZONE2/3-högtalarkontakterna (endast kompatibla modeller). Om någon annan kontakt används för anslutningen, justera volymen på ljudutrustningen i det andra rummet.
- För att uppleva Spotify-musik i huvudrummet efter att du har spelat Spotify i ett annat rum, välj ”NET” som ingångskälla för huvudrummet.

Automatiskt strömpåslag

- Genom att slå på nätverks-standby kan du använda funktionen för automatiskt strömpåslag när du använder Spotify-applikationen.

■ Spotify Connect -tuki

Spotify Connect voidaan tukea päivittämällä laitteen ohjelmisto. Napsauta Connect-kuvaketta ja valitse laite Spotify-sovelluksen toistonäytössä nauttiaksesi korkealaatuisesta musiikin suoratoistosta. Ota Spotify Connect käyttöön asentamalla Spotify-sovellus ensin älypuhelimellesi tai tablettiisi. Luo sitten Spotify Premium -tili.

* Spotify-ohjelmistoon sovelletaan kolmannen osapuolen lisenssejä, jotka löytyvät täältä:
www.spotify.com/connect/third-party-licenses

Huomautuksia monivyöhyketoiminnon käytöstä

- Nauti Spotify-musiikista erillisessä huoneessa valitsemalla erillisen huoneen tulolähteeksi ”NET”.
- Äänenvoimakkuuden säätö Spotify-sovelluksella on mahdollista vain laitteella, joka on kytketty ZONE2/3-kaiuttimiliitäntään (vain yhteensopiva malli). Jos jotain muuta kaiutinpäätettä käytetään kytkemisessä, säädä äänenvoimakkuutta äänentoistolaitteesta joka sijaitsee erillisessä huoneessa.
- Kun haluat nauttia Spotify-musiikista päähuoneessa sen jälkeen kun Spotify-musiikkia on toistettu erillisessä huoneessa, valitse ”NET” tulolähteeksi päähuoneessa.

Automaattinen virta päälle -toiminto

- Kytkeällä verkon valmiustilan päälle voit käyttää automaattista virta päälle -toimintoa, kun käytät Spotify-sovellusta.